

LARGA

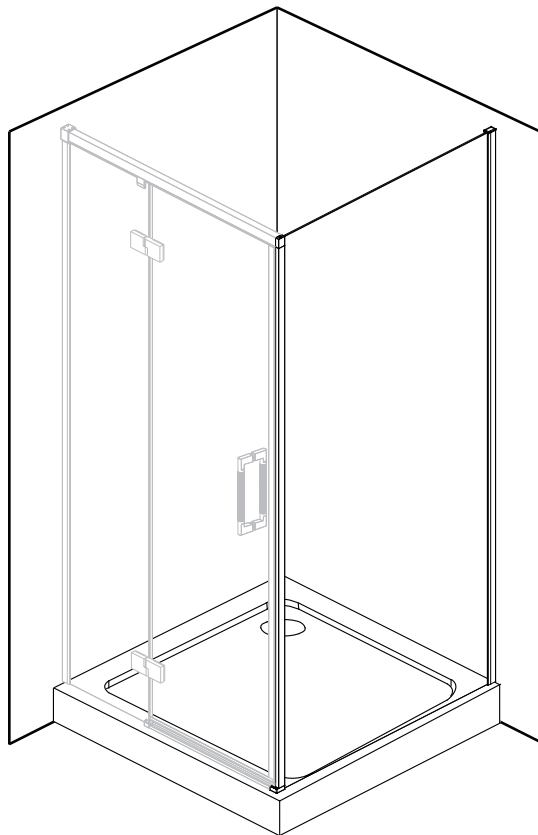

PL INSTRUKCJA MONTAŻU I EKSPLOATACJI

CZ NÁVOD NA MONTÁŽ A ÚDRŽBU

SK NÁVOD NA MONTÁŽ A ÚDRŽBU

EST PAIGALDUS- JA KASUTUSJUHEND

LT MONTAVIMO IR EKSPLOATAVIMO INSTRUKCIJA

LV MONTĀŽAS UN EKSPLUATĀCIJAS INSTRUKCIJA

DE MONTAGE- UND AUFBAUANLEITUNG

RO INSTRUCȚIUNI DE MONTAJ ȘI OPERARE

HU SZERELÉSI ÉS ÜZEMELTETÉSI ÚTMUTATÓ

UA ІНСТРУКЦІЯ З МОНТАЖУ І ЕКСПЛУАТАЦІЇ

BY ІНСТРУКЦЫЯ ПА МАНТАЖЫ І ЭКСПЛУАТАЦЫІ

RU ИНСТРУКЦИЯ ПО МОНТАЖУ И ЭКСПЛУАТАЦИИ

EN INSTRUCTIONS FOR ASSEMBLY AND USE

FR INSTALLATION ET UTILISATION - MODE

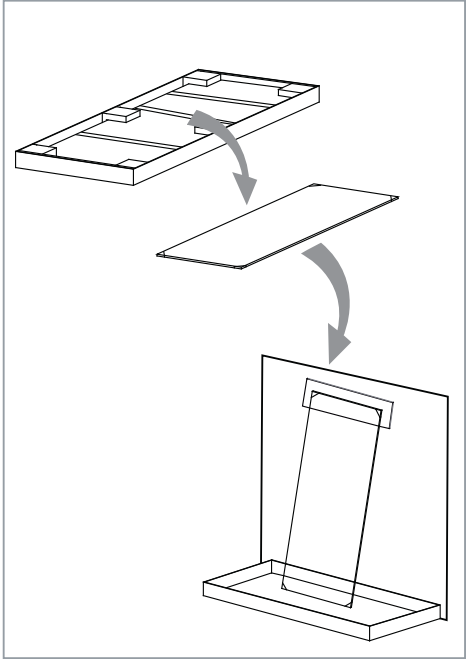
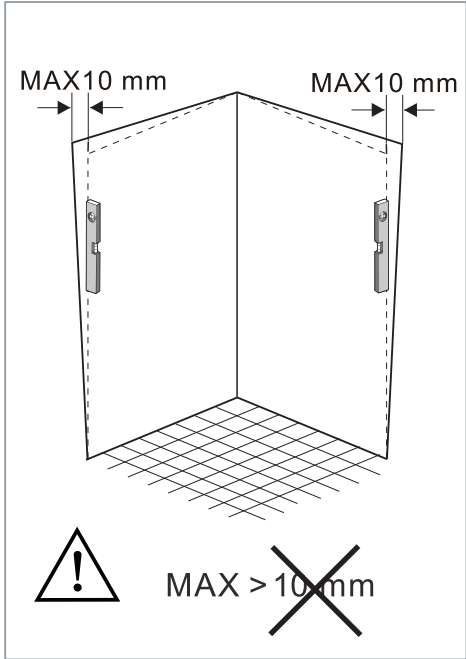
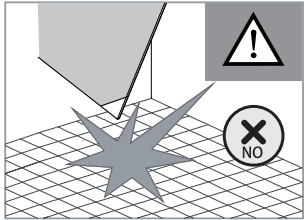
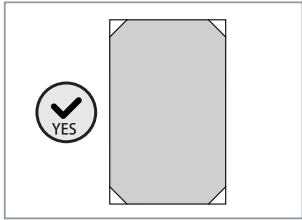
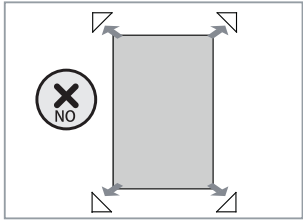
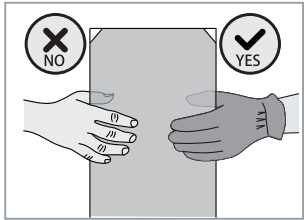
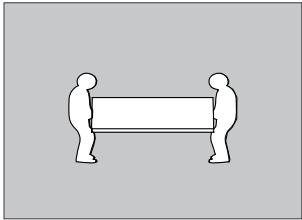
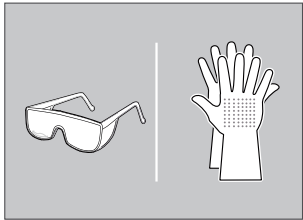
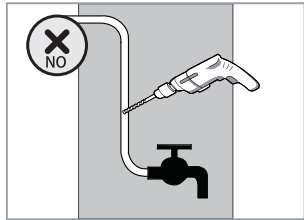
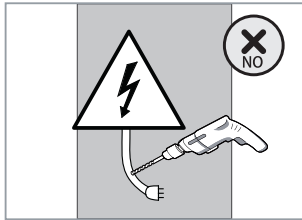
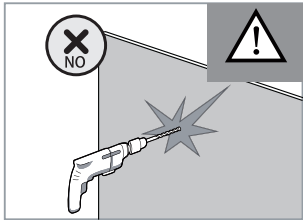

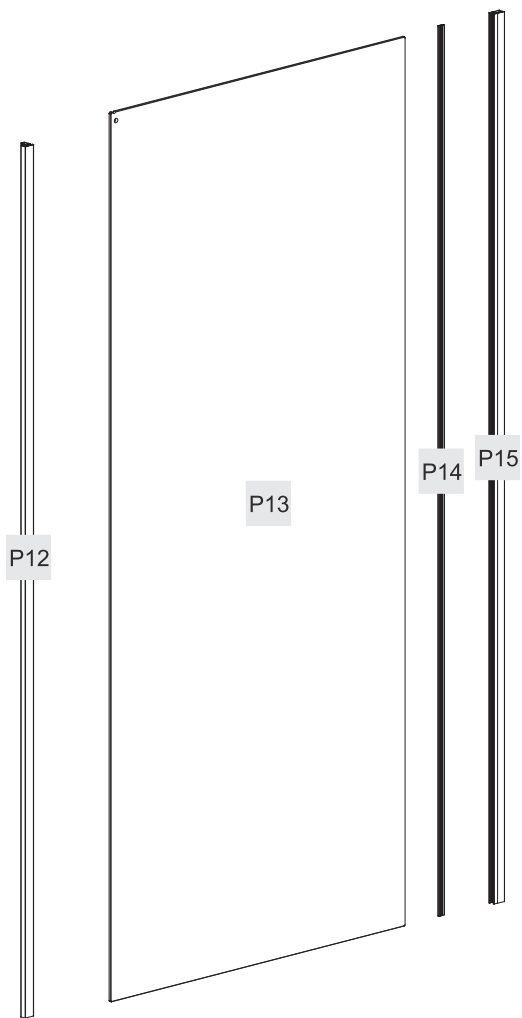

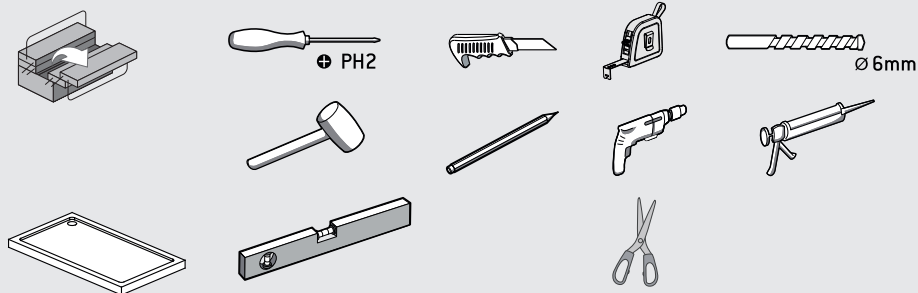
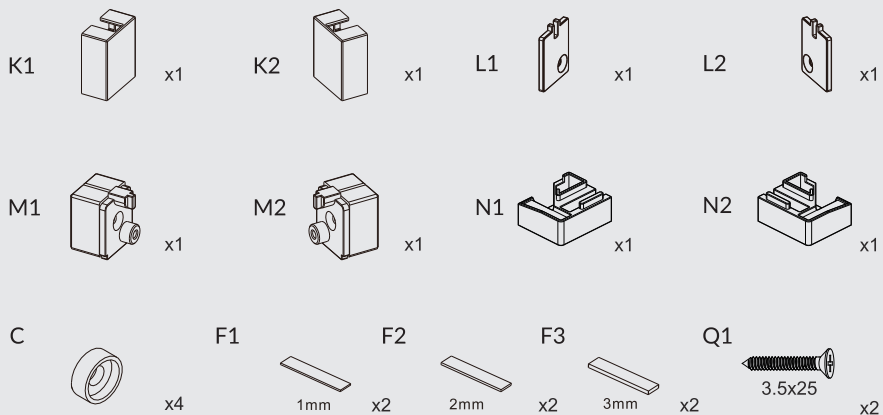
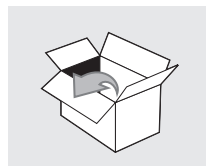
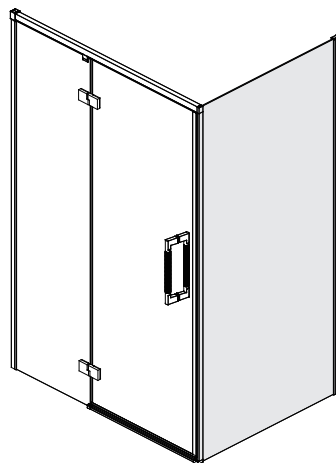

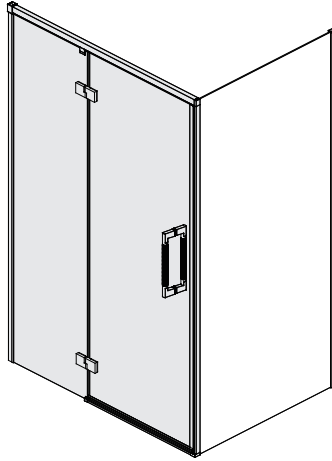

G1



x1

G2



x1

G3



Ø2 x1

G4



Ø3 x1

A



x2

B



x2

A



x8

B



x8

C



x4

D1



x1

D2



x1

D3



x1

D4



x1

E1



x1

E2



x1

E3



x1

F1



1mm x2

F2



2mm x2

F3



3mm x2

H

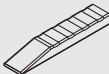

x1

J



Ø4 x1

1.

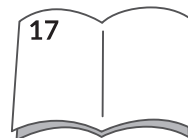
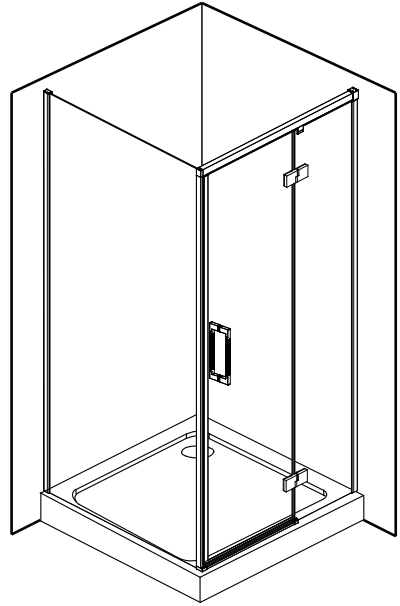
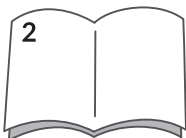
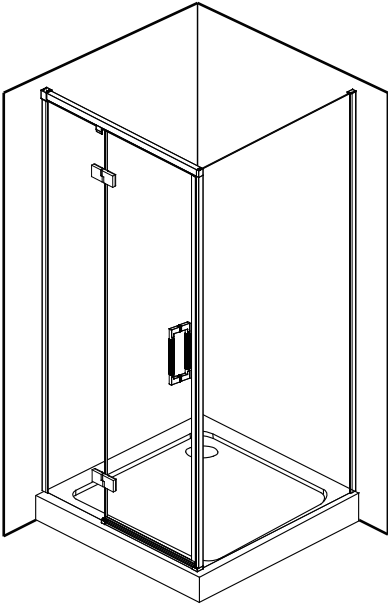

2.

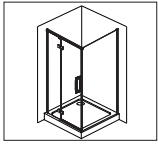

SIZE	X(mm)	Y(mm)
800X800X1950	783	795
800X900X1950	783	895
800X1000X1950	783	995
800X1200X2000	783	1195
900X800X1950	883	795
900X900X1950	883	895
900X1000X1950	883	995
900X1200X2000	883	1195

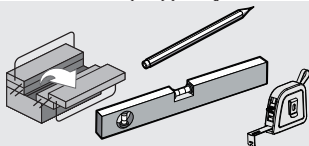
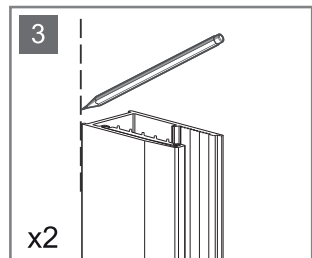
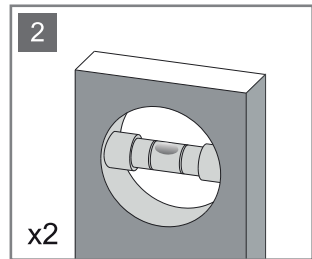
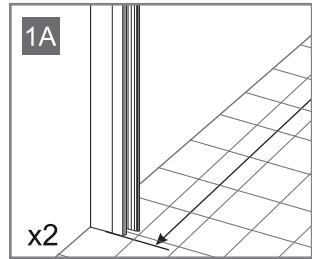
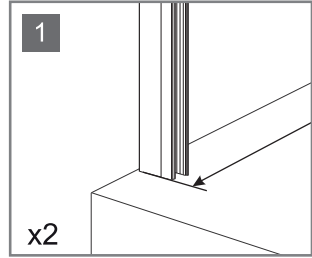
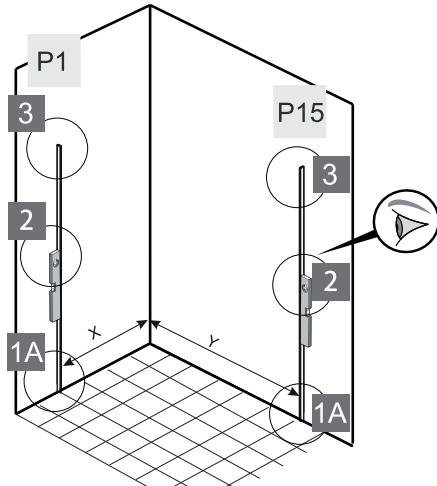
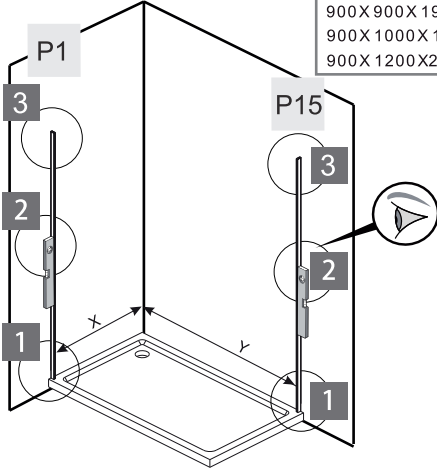

P1  x1

P15  x1



3.

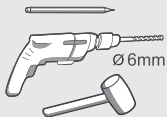
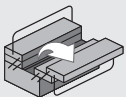
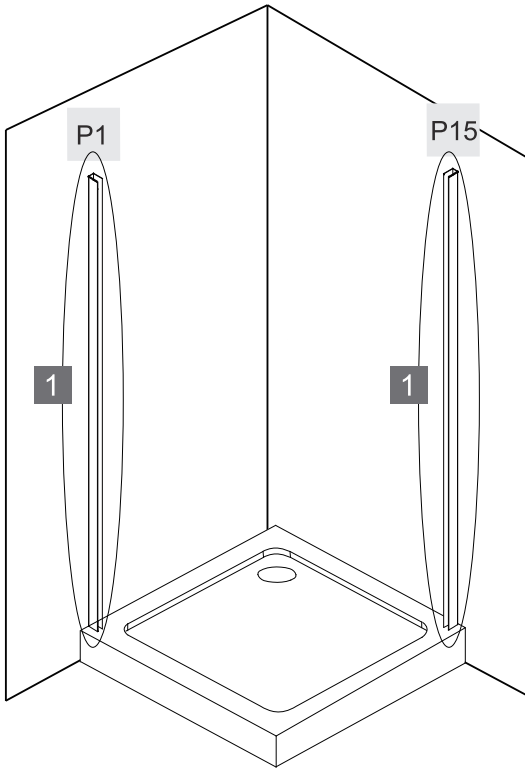
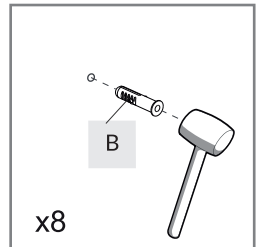
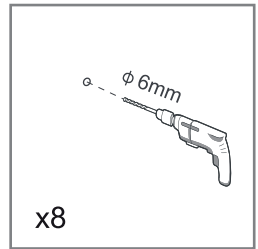
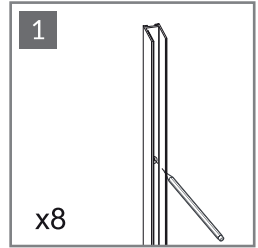
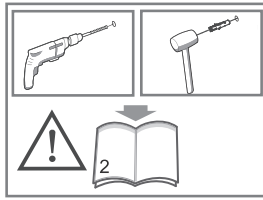
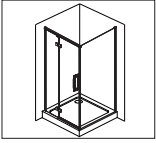

B



x8



4.

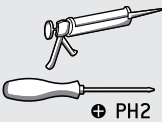
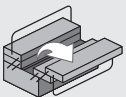
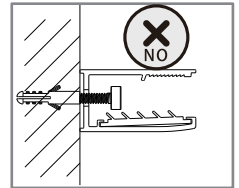
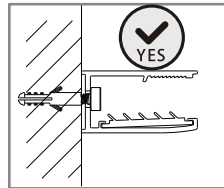
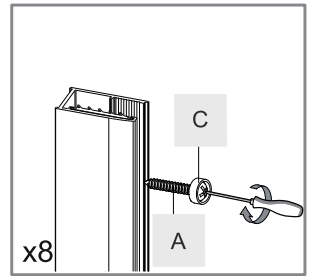
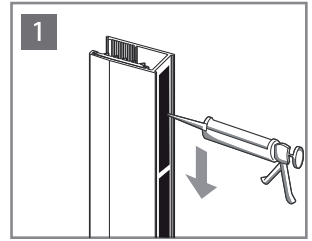
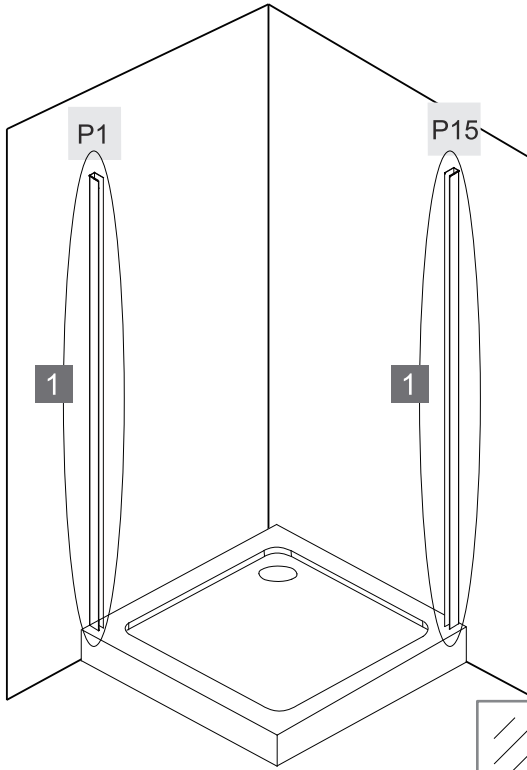
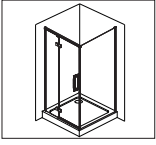

A



x8

C



x8



5.

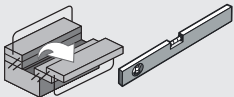
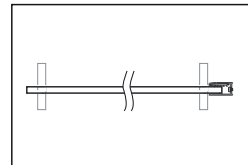
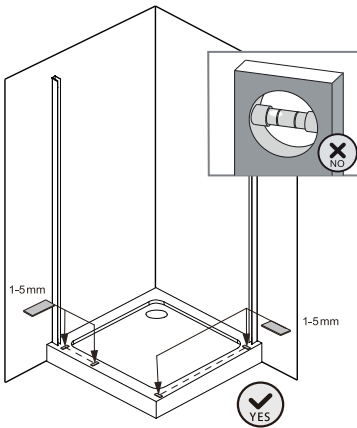
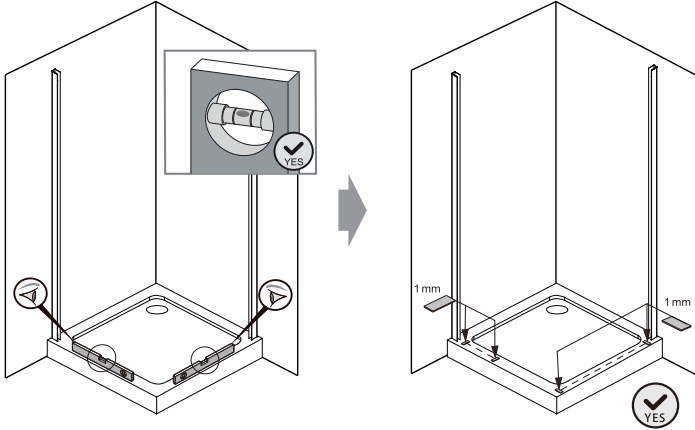
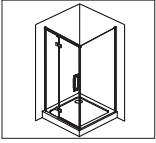

F1



x4

F2



x4

F3



x4



6.

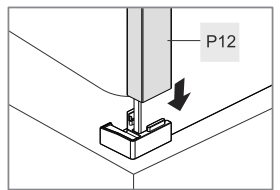
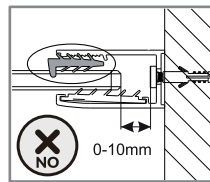
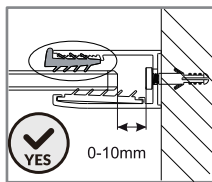
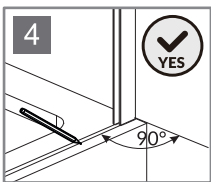
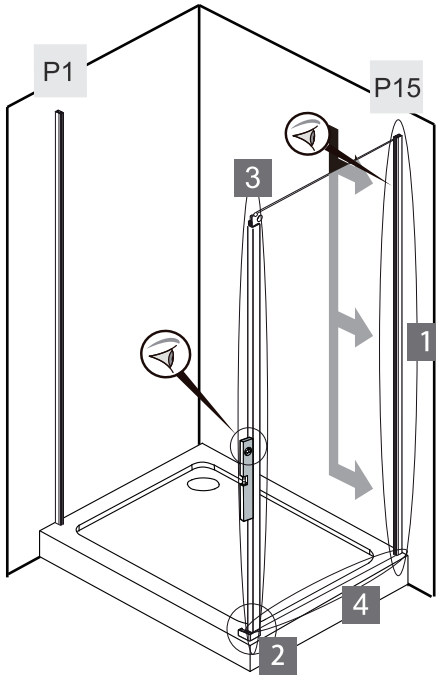
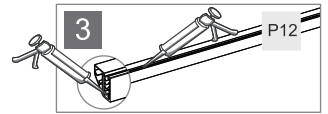
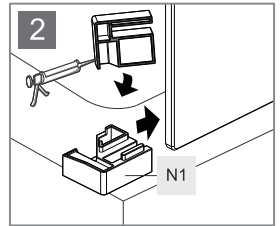
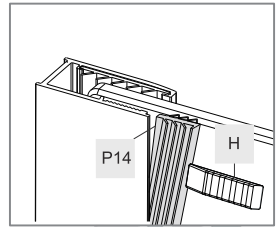
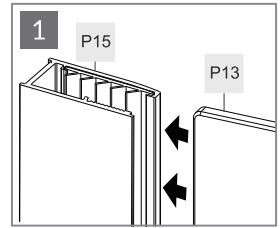
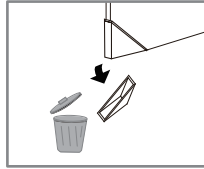
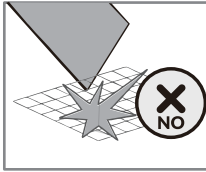
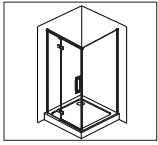

7.

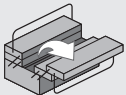
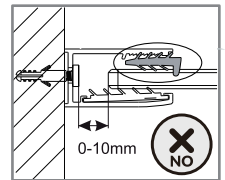
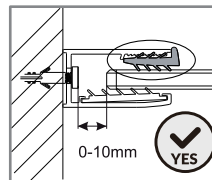
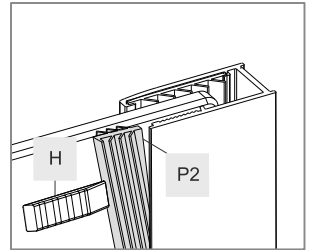
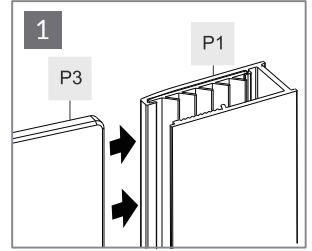
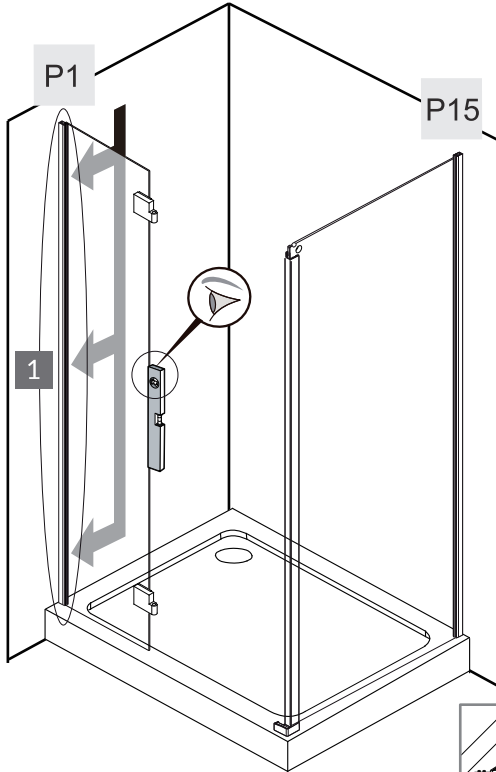
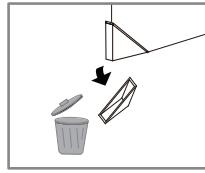
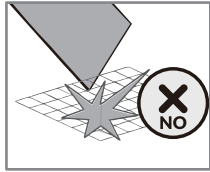
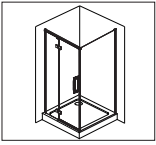

P2 ————— x1

H ————— x1

P3 ————— x1



8.

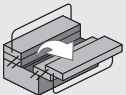
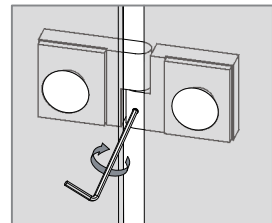
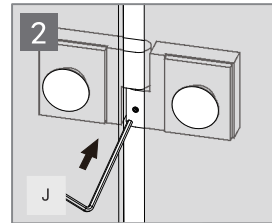
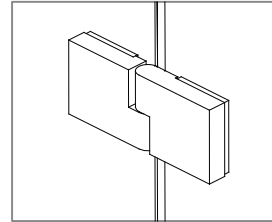
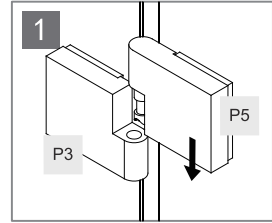
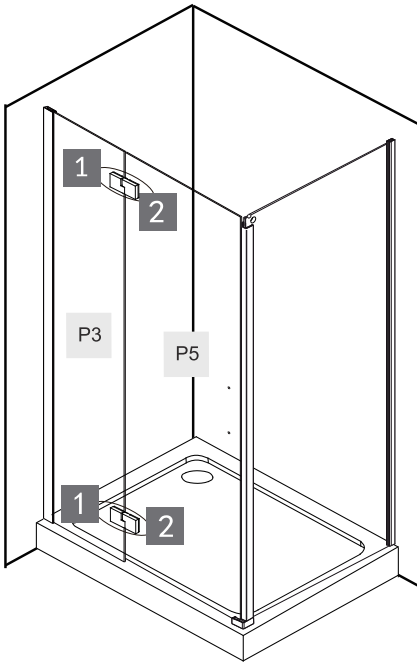
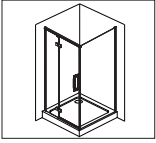

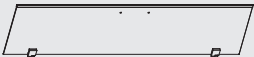
P5  x1



J  x1

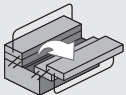
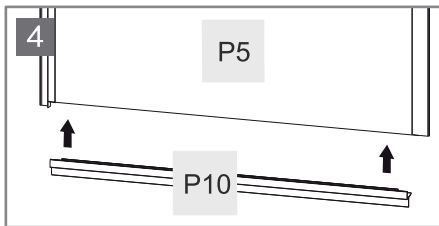
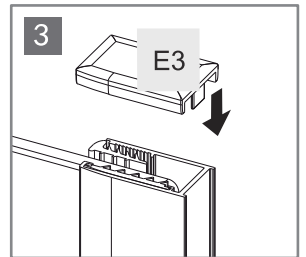
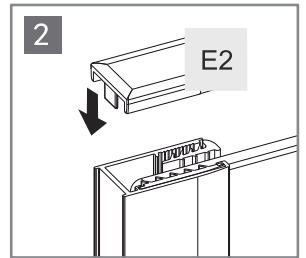
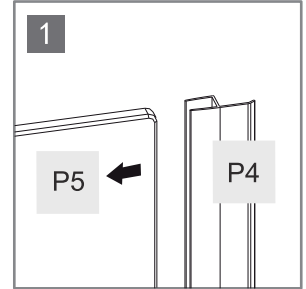
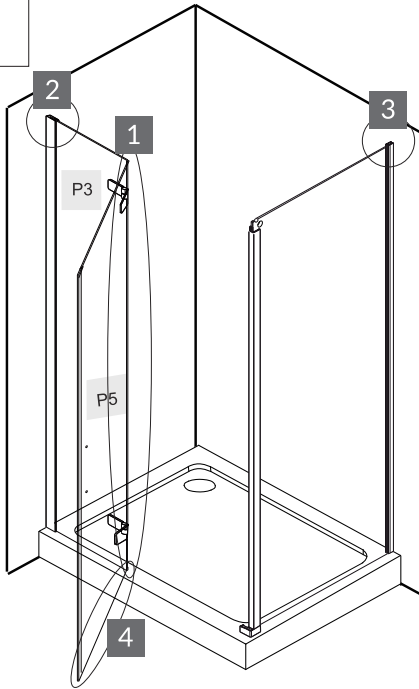
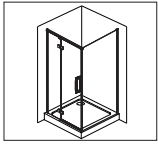

9.



P4  x1
P10  x1

E2  x1
E3  x1



10.

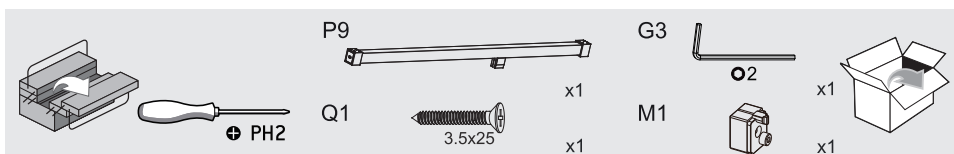
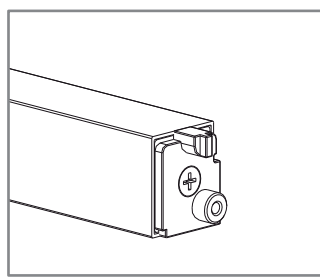
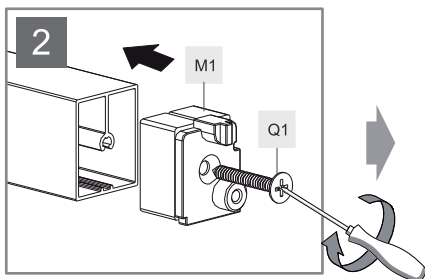
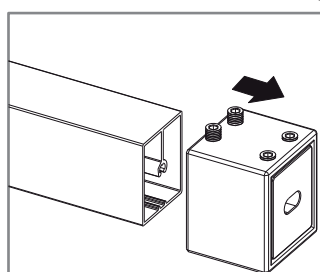
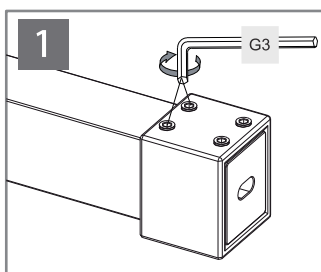
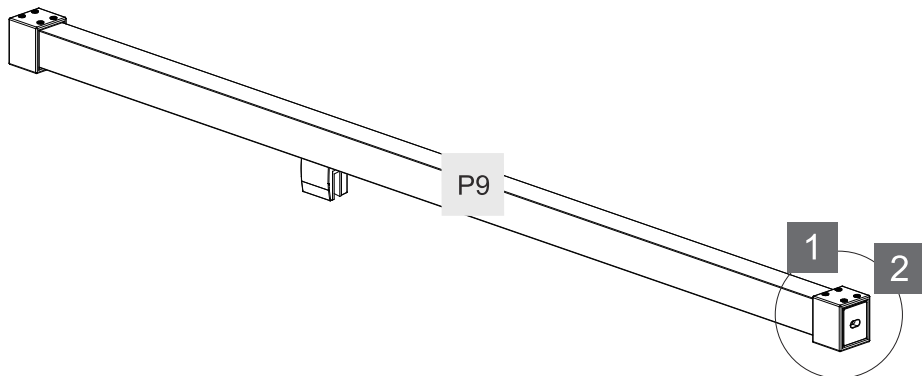
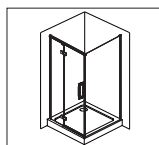

11.

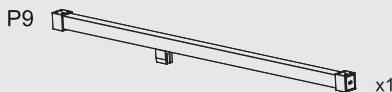
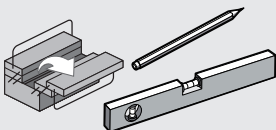
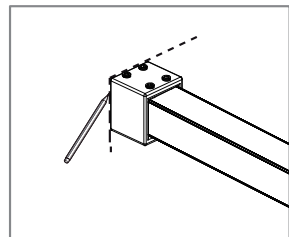
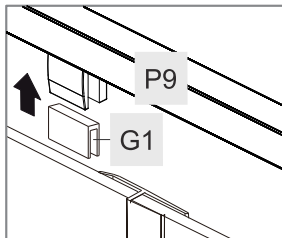
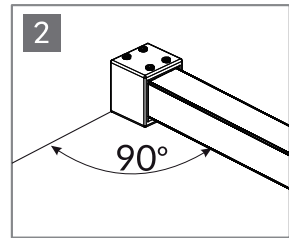
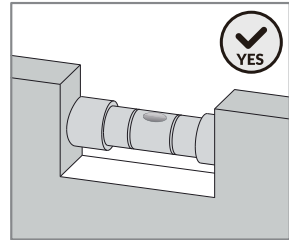
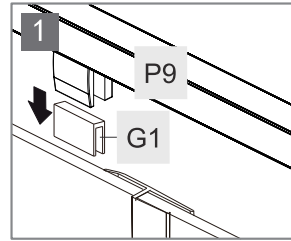
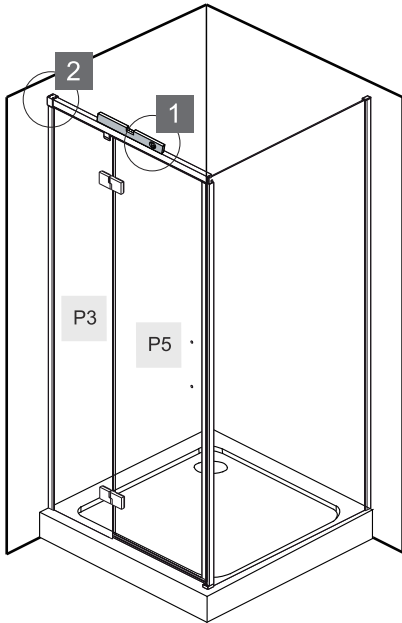
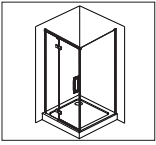

12.

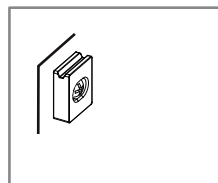
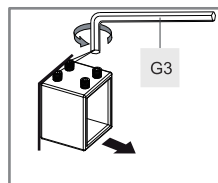
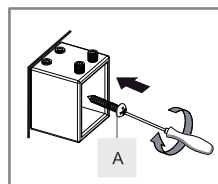
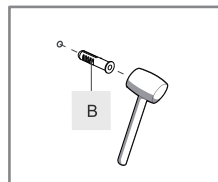
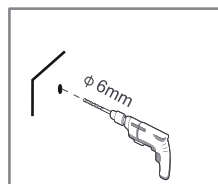
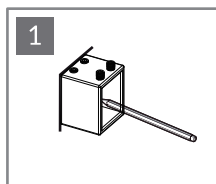
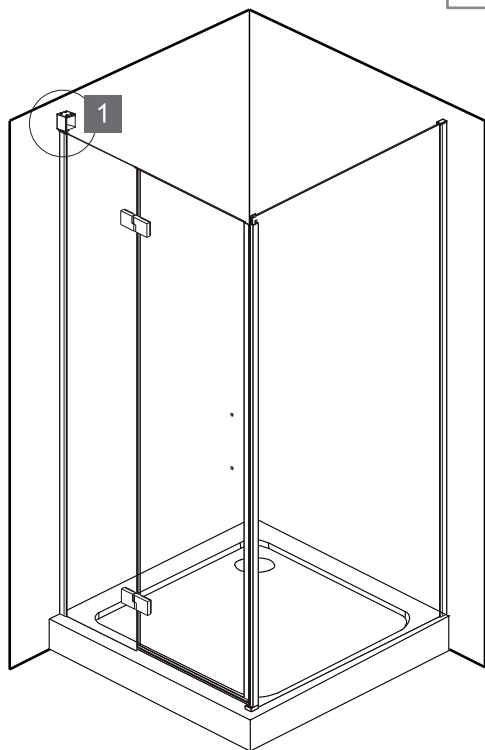
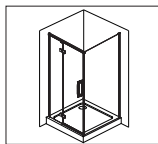

			A		x1	
		B		x1		
		G3		x1		

13.

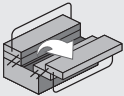
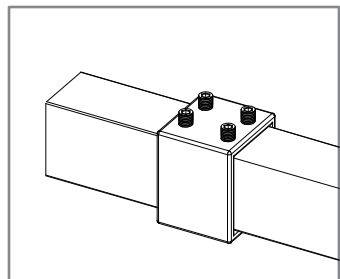
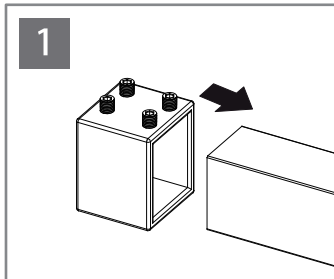
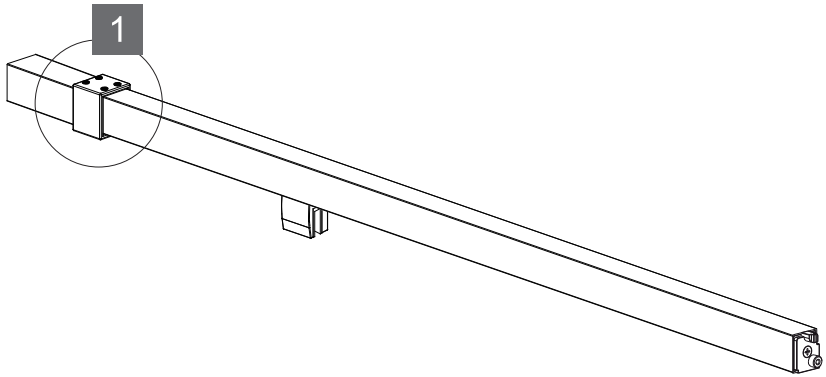
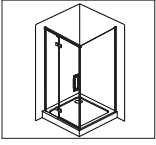

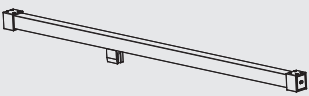
P9  x1



14.

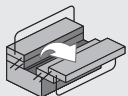
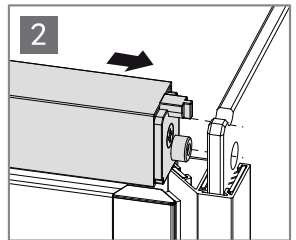
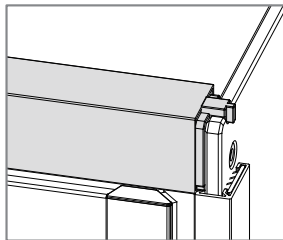
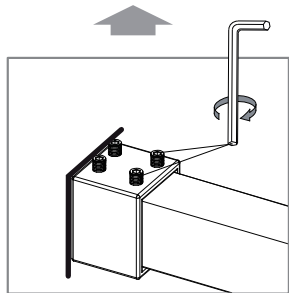
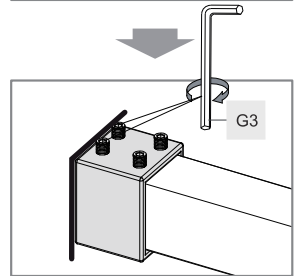
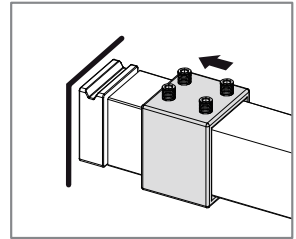
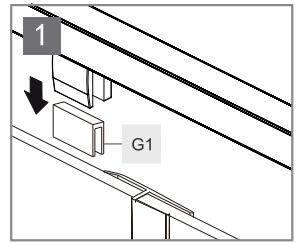
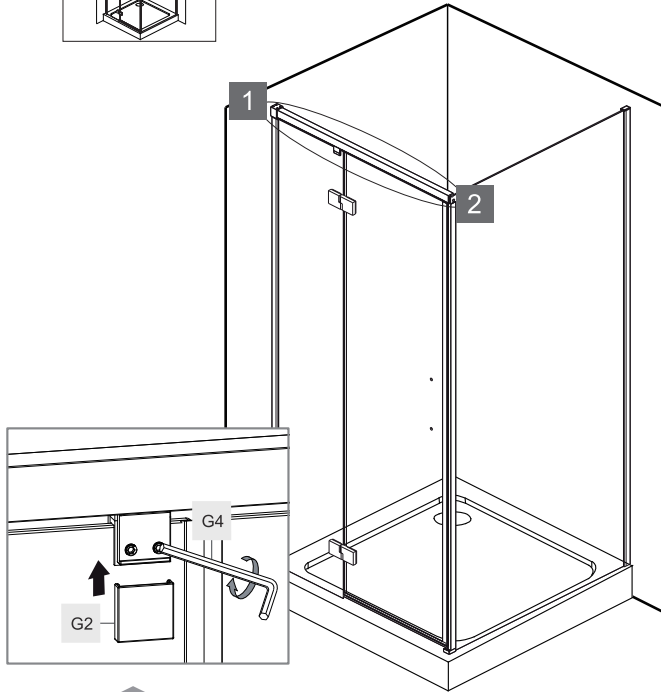
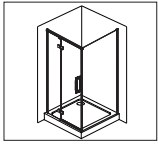

G1



x1



x1

G3



x1



x1



15.

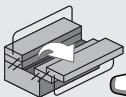
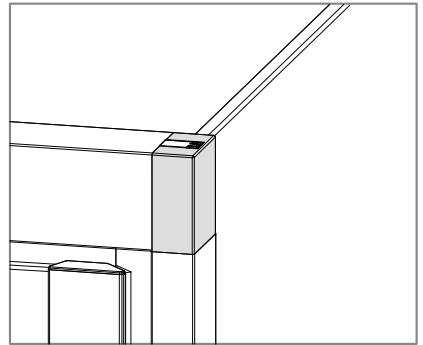
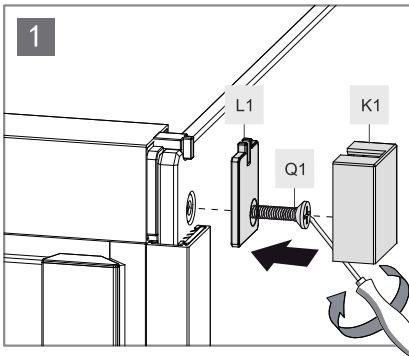
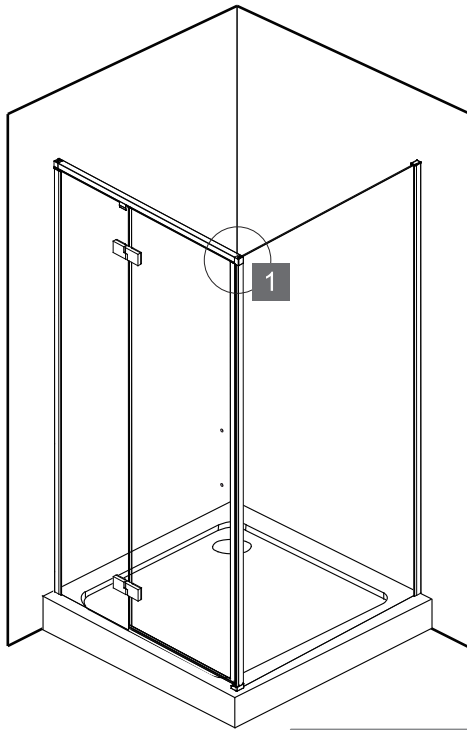
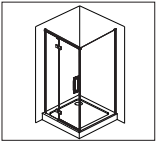

L1



x1

Q1

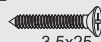

x1

K1



x1



PH2

16.

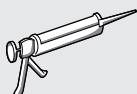
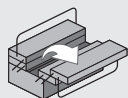
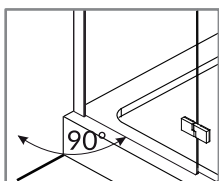
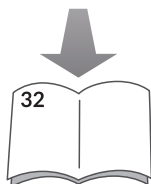
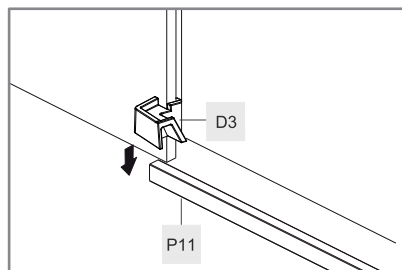
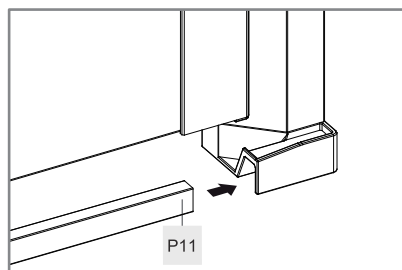
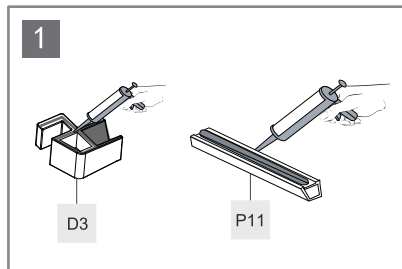
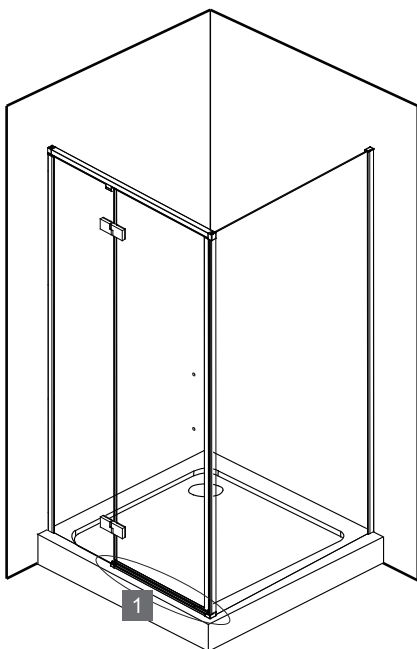
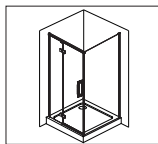

D3  x1

P11  x1



17.

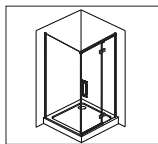

SIZE	X(mm)	Y(mm)
800X800X1950	783	795
800X900X1950	783	895
800X1000X1950	783	995
800X1200X2000	783	1195
900X800X1950	883	795
900X900X1950	883	895
900X1000X1950	883	995
900X1200X2000	883	1195

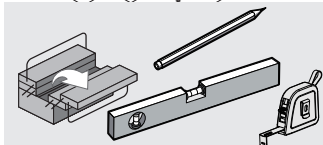
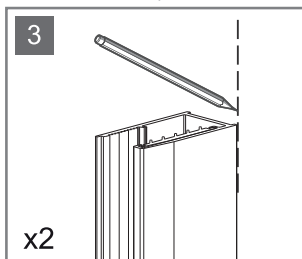
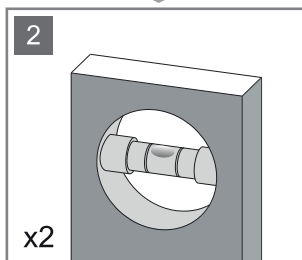
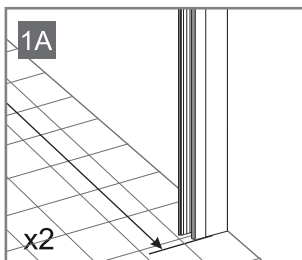
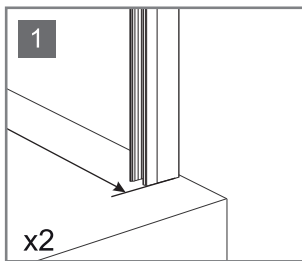
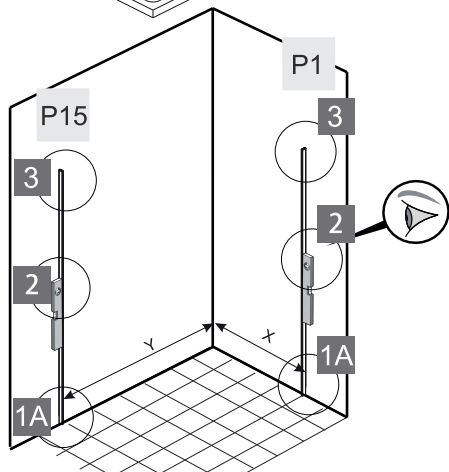
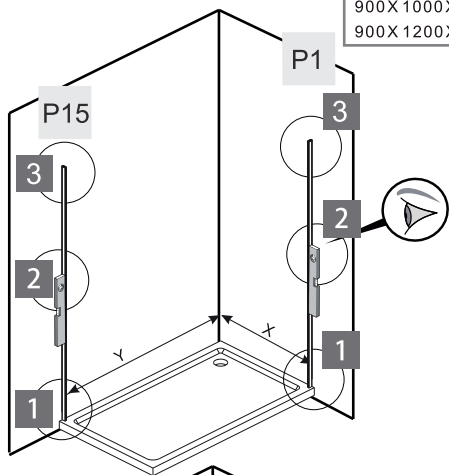

P1  x1

P15  x1



18.

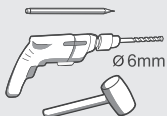
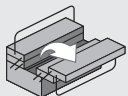
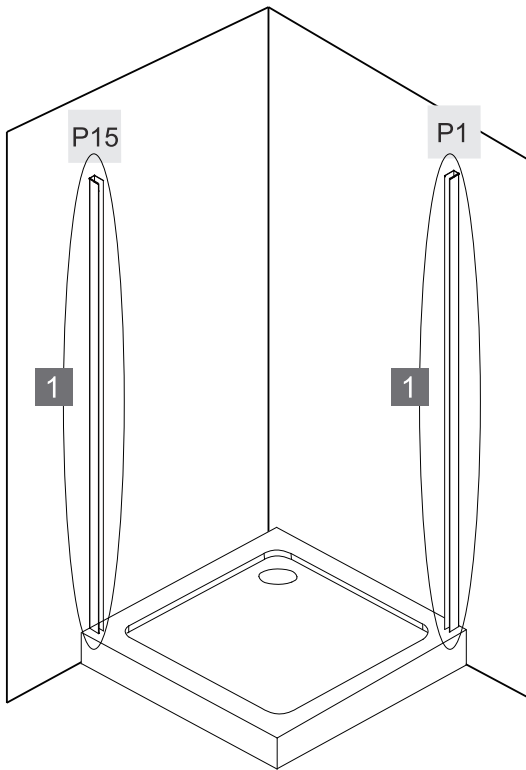
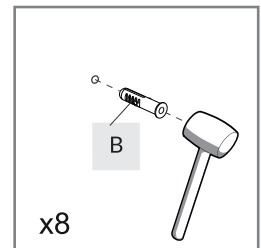
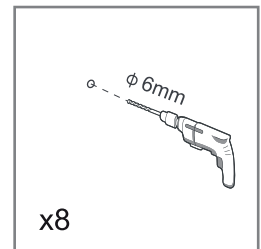
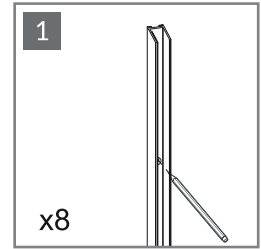
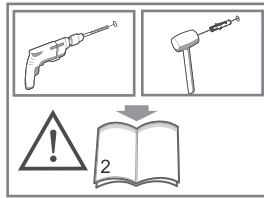
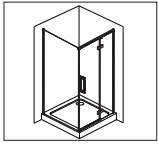

B



x8



19.

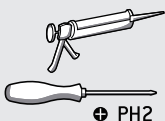
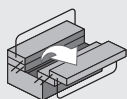
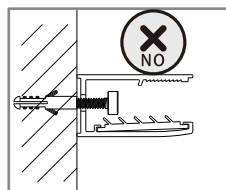
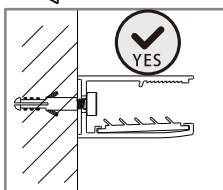
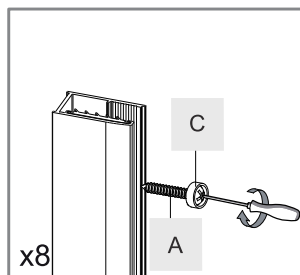
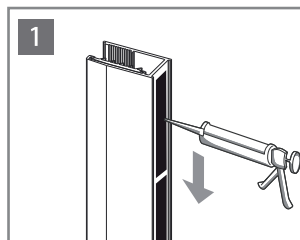
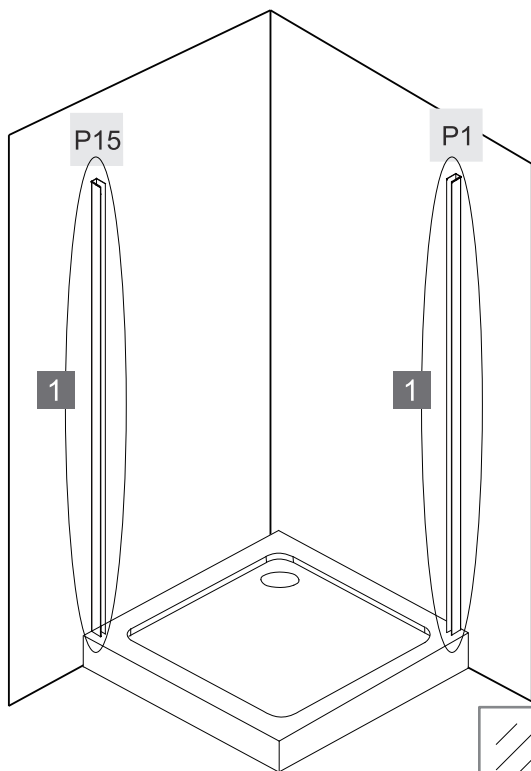
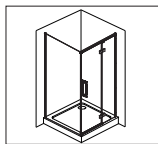

A



x8

C



x8



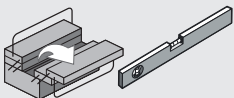
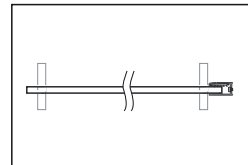
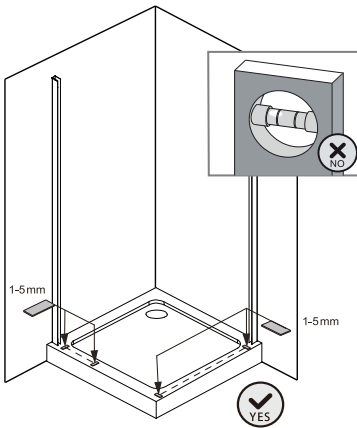
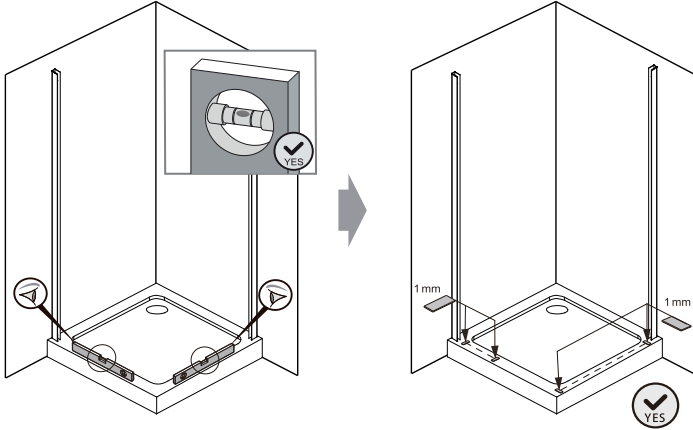
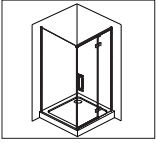

F1



x4

F2



x4

F3



x4



21.

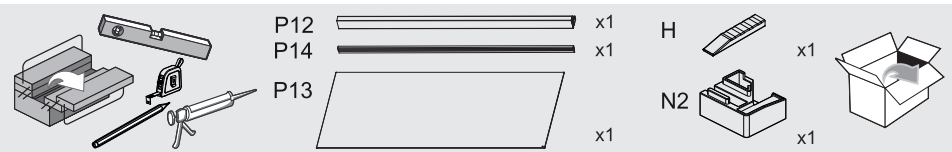
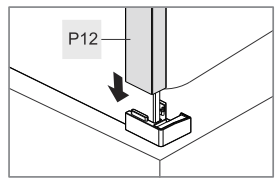
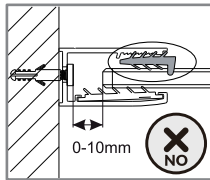
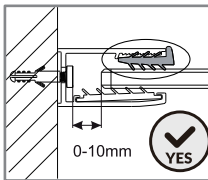
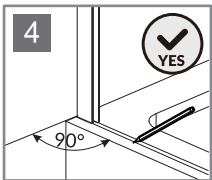
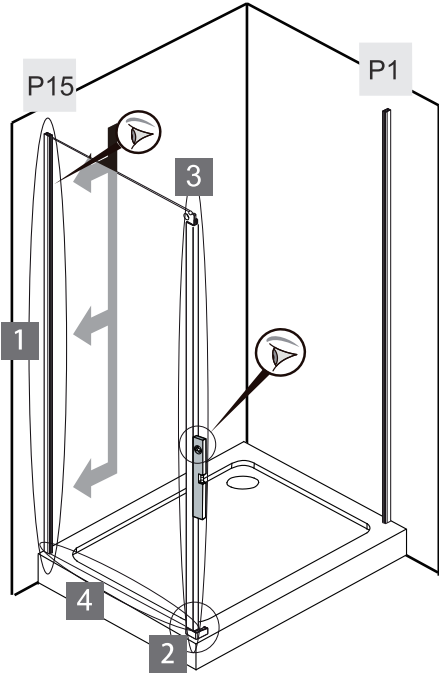
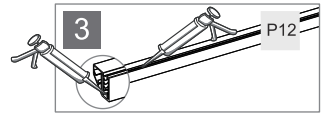
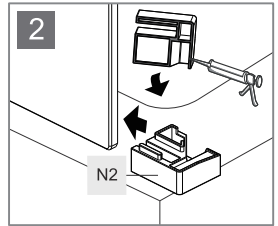
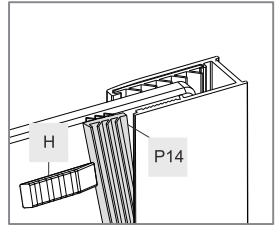
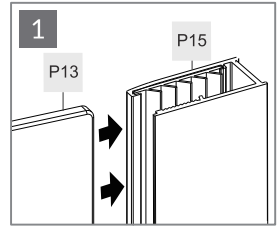
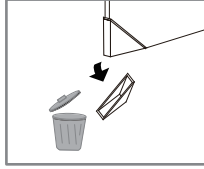
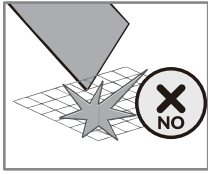
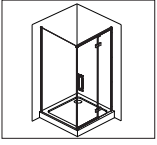

22.

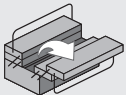
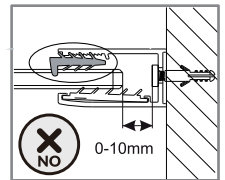
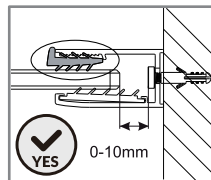
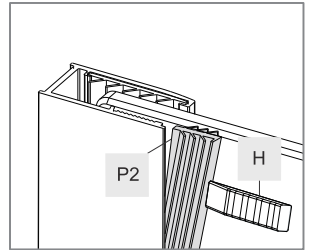
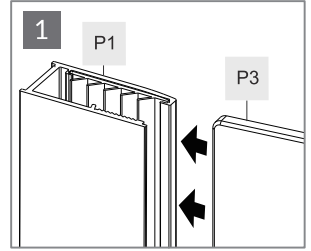
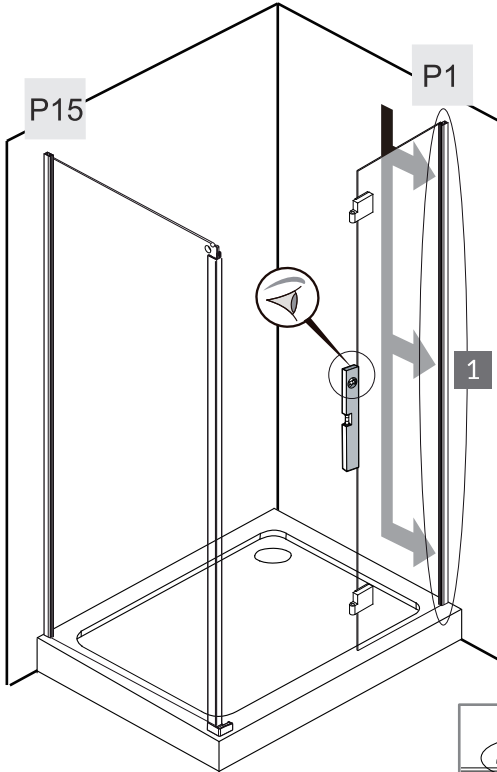
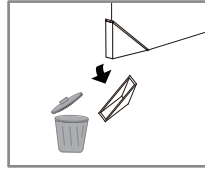
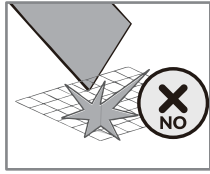
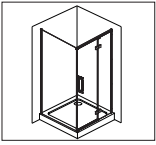

P2 ————— x1 H

P3 ————— x1





x1

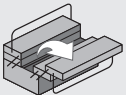
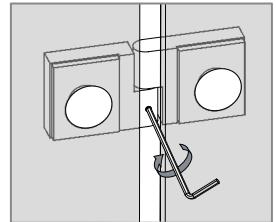
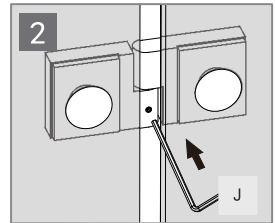
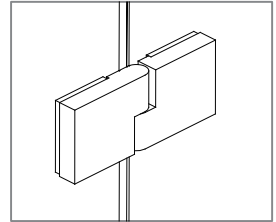
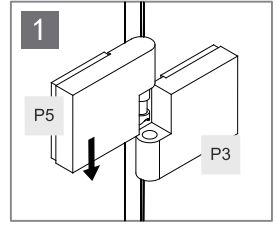
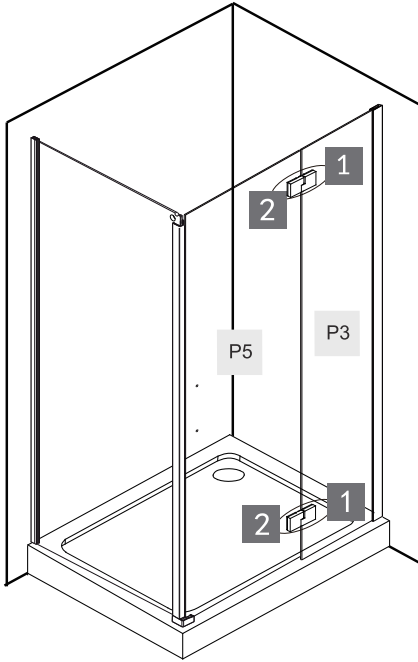
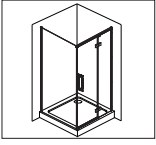

23.

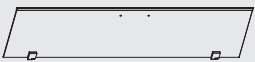

P5  x1

J  x1



24.

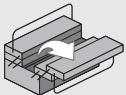
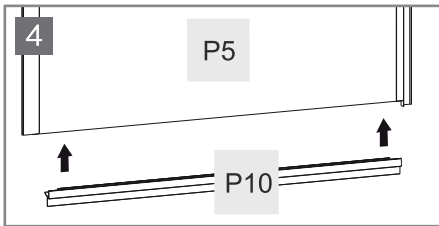
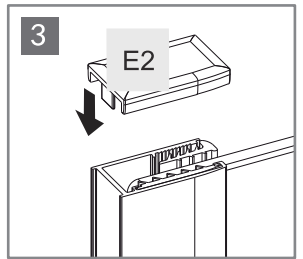
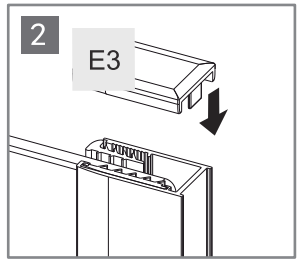
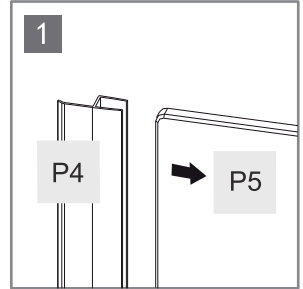
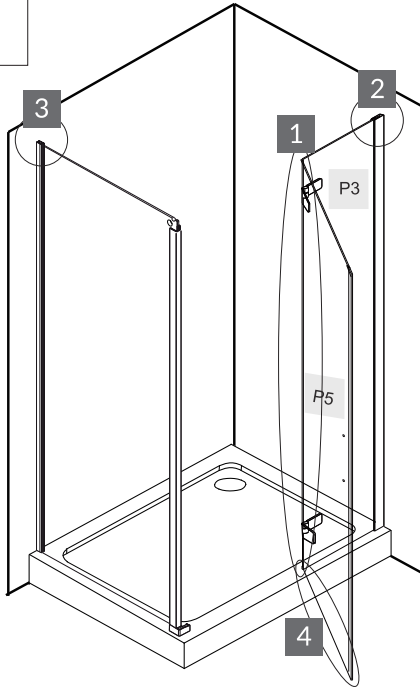
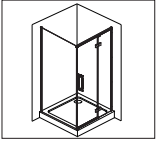

P4  x1

E2  x1

P10  x1

E3  x1



25.

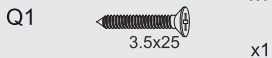
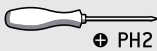
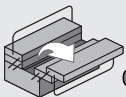
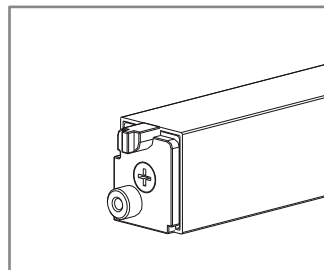
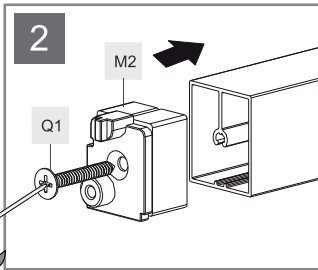
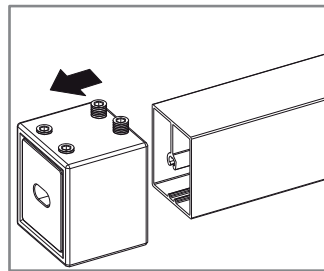
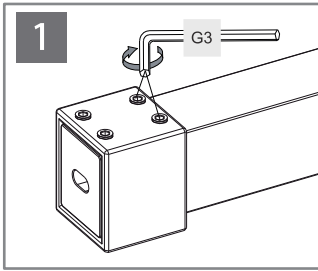
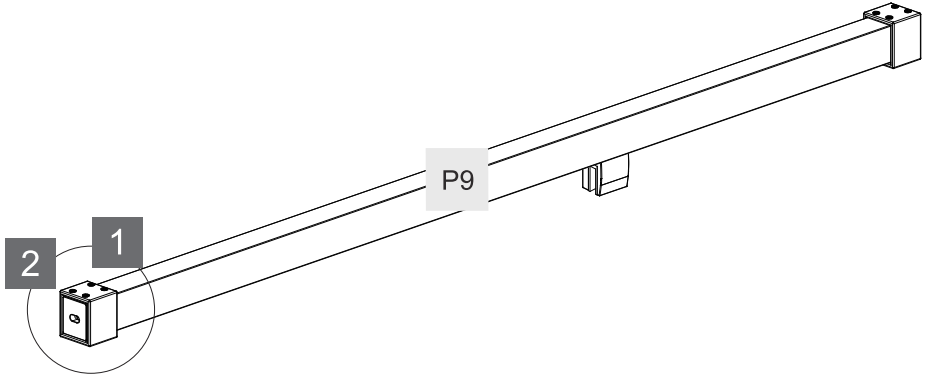
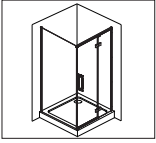

x1

x1

x1



x1

x1

x1

26.

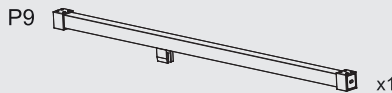
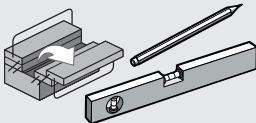
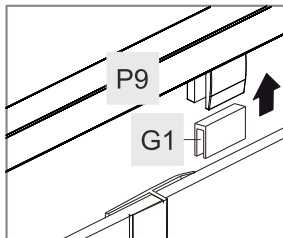
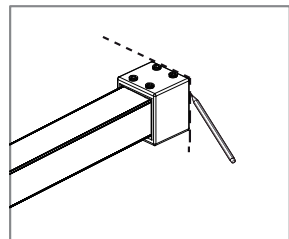
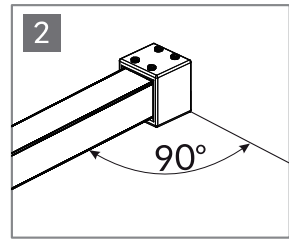
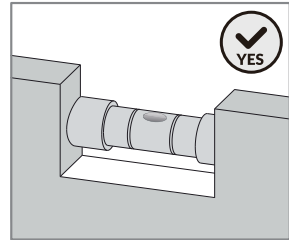
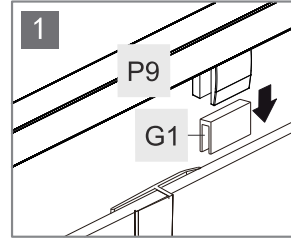
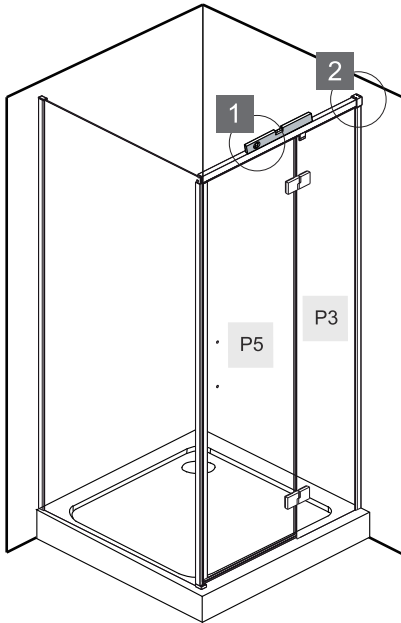
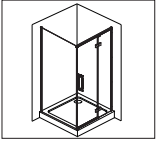

27.

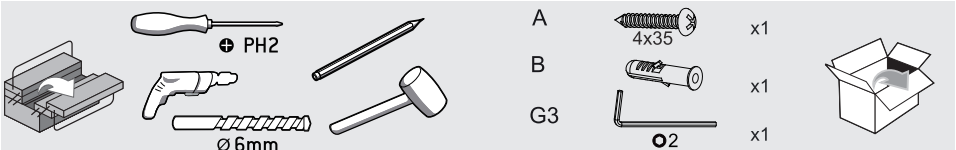
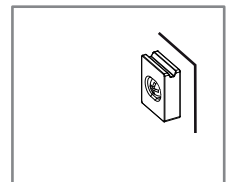
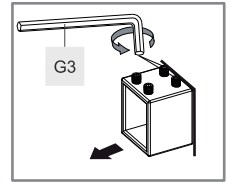
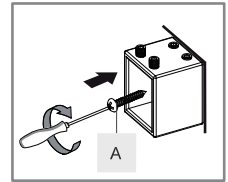
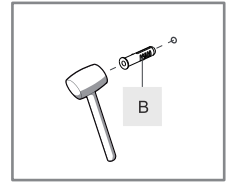
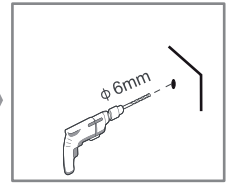
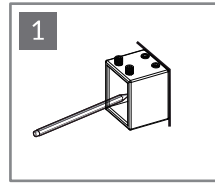
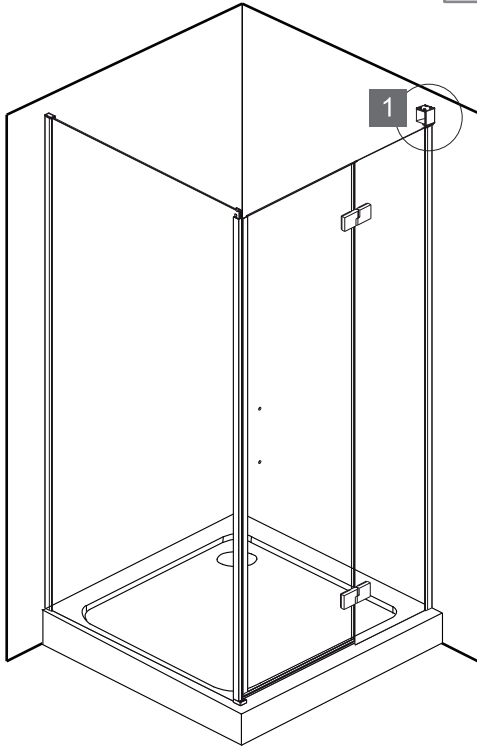
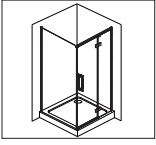

28.

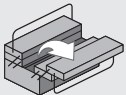
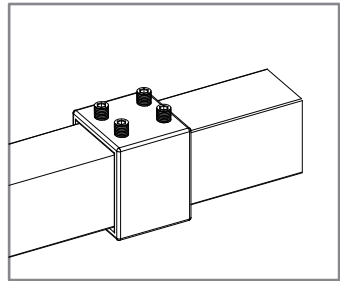
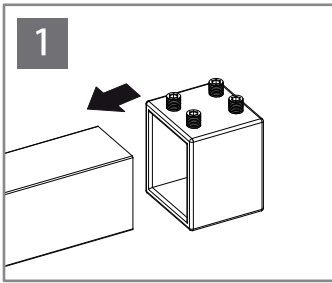
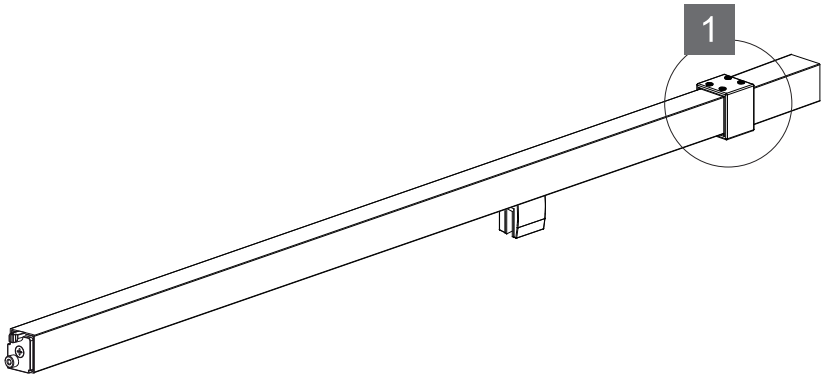
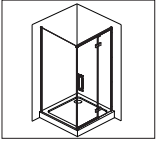

P9

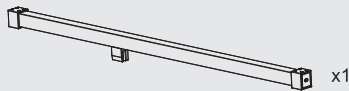

x1



29.

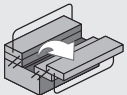
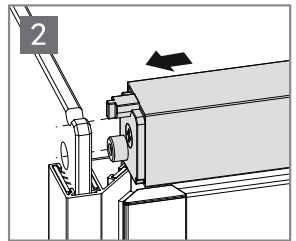
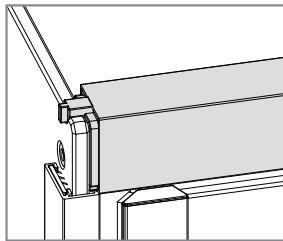
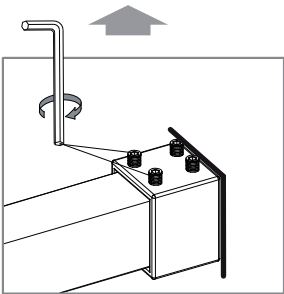
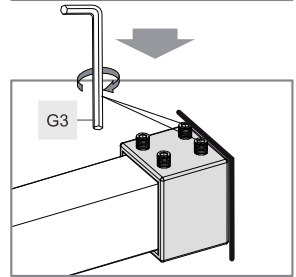
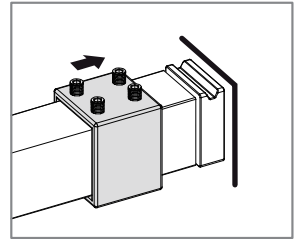
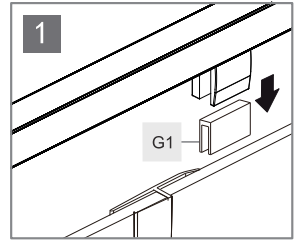
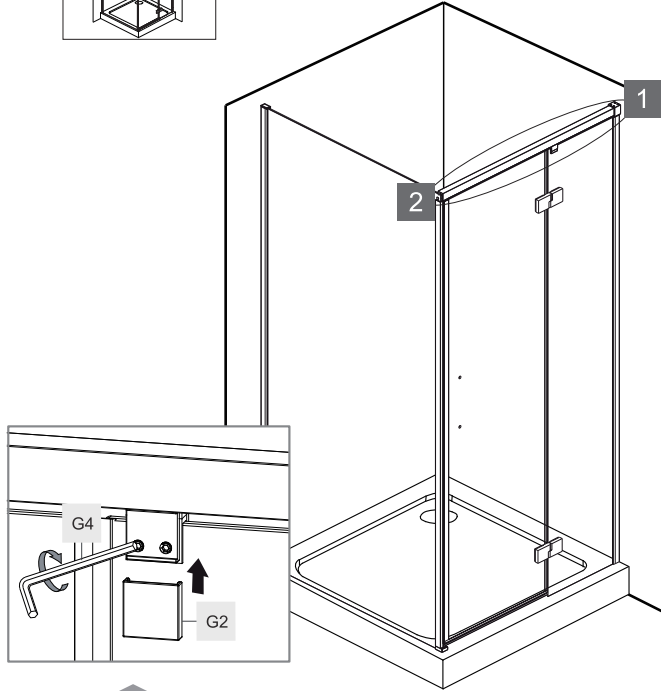
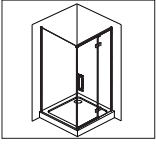

G1



x1

G2



x1

G3



x1

G4



x1



30.

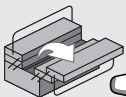
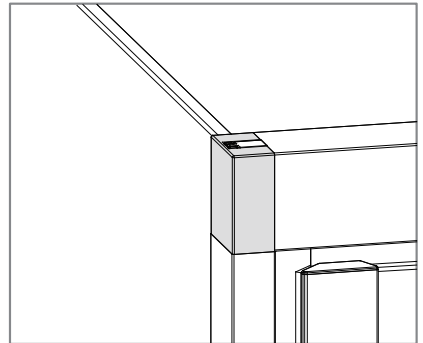
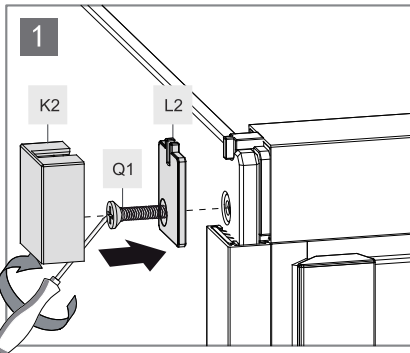
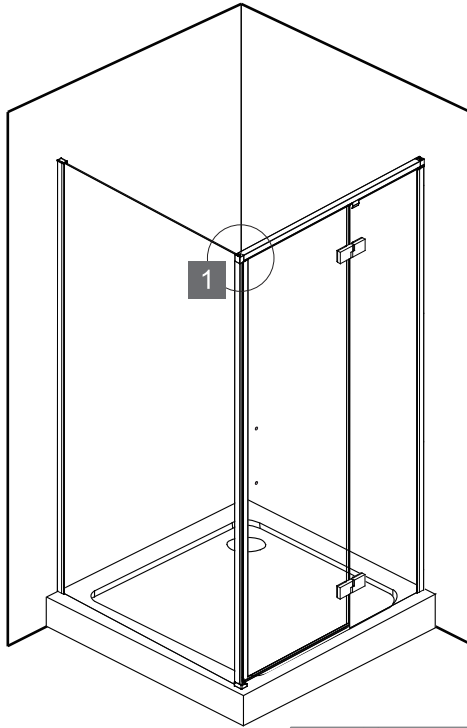
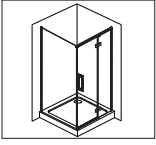

L2



x1

Q1

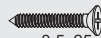

3.5x25 x1

K2



x1



PH2

31.

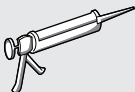
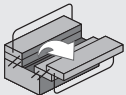
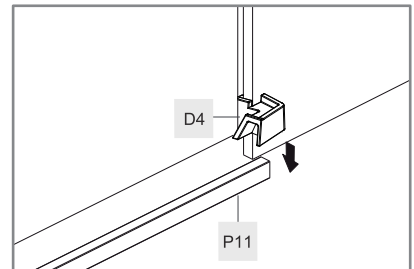
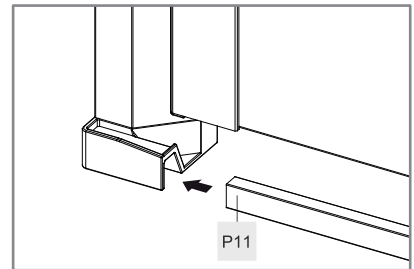
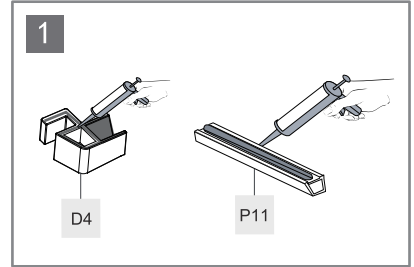
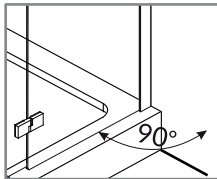
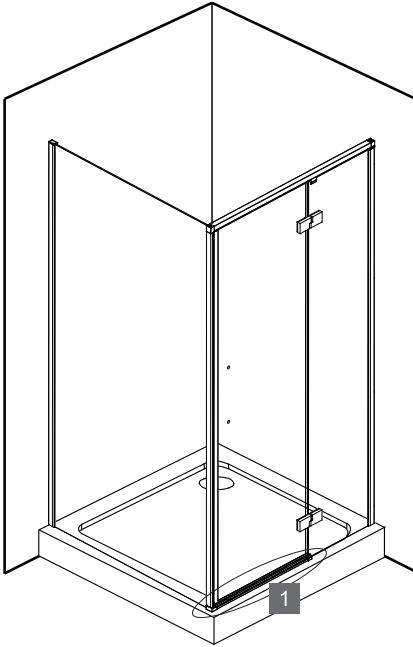
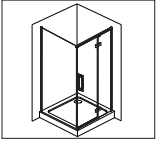

D4  x1

P11  x1



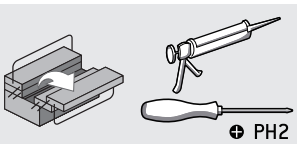
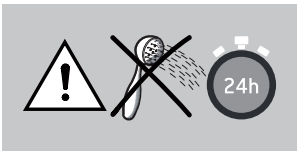
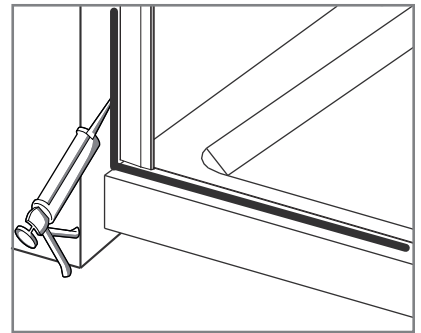
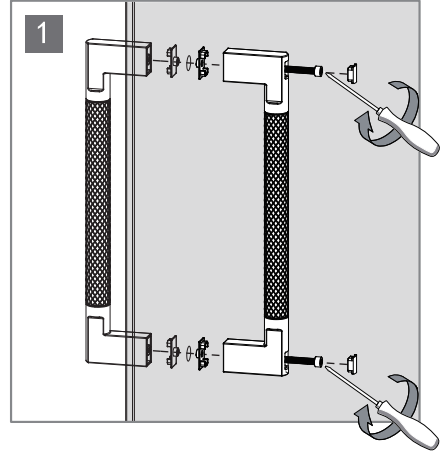
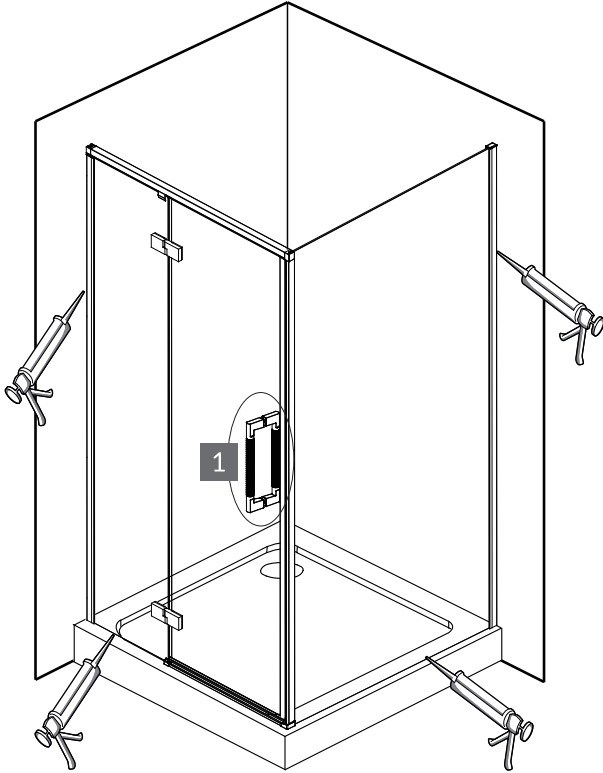

P6



x1





6.5 < PH < 7.5

