

# CREA

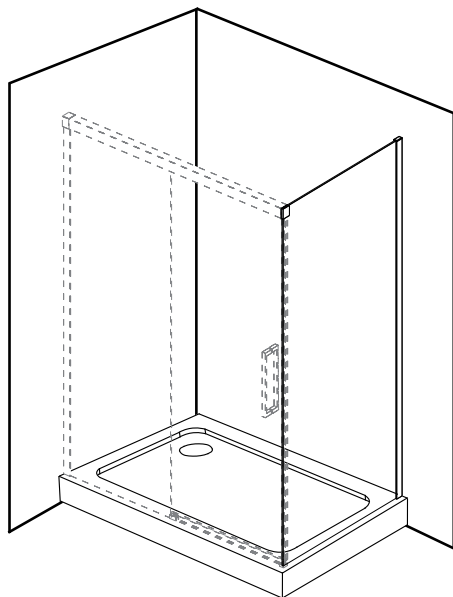

PL INSTRUKCJA MONTAŻU I EKSPLOATACJI

CZ NÁVOD NA MONTÁŽ A ÚDRŽBU

SK NÁVOD NA MONTÁŽ A ÚDRŽBU

EST PAIGALDUS- JA KASUTUSJUHEND

LT MONTAVIMO IR EKSPLOATAVIMO INSTRUKCIJA

LV MONTĀŽAS UN EKSPLUATĀCIJAS INSTRUKCIJA

DE MONTAGE- UND AUFBAUANLEITUNG

RO INSTRUCȚIUNI DE MONTAJ ȘI OPERARE

HU SZERELÉSI ÉS ÜZEMELTETÉSI ÚTMUTATÓ

UA ІНСТРУКЦІЯ З МОНТАЖУ І ЕКСПЛУАТАЦІЇ

BY ІНСТРУКЦЫЯ ПА МАНТАЖЫ І ЭКСПЛУАТАЦЫІ

RU ИНСТРУКЦИЯ ПО МОНТАЖУ И ЭКСПЛУАТАЦИИ

EN INSTRUCTIONS FOR ASSEMBLY AND USE

FR INSTALLATION ET UTILISATION - MODE

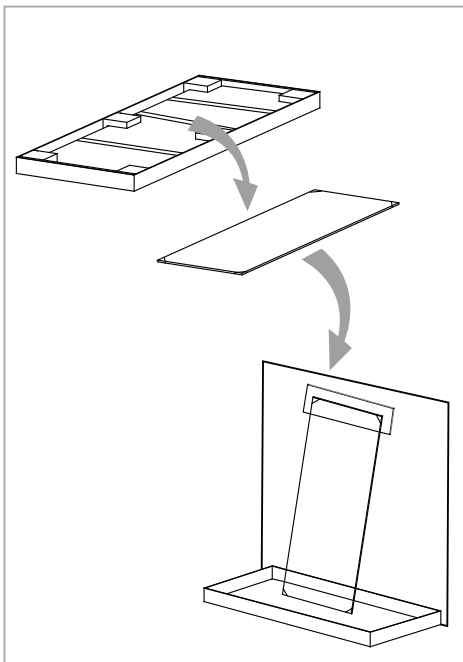
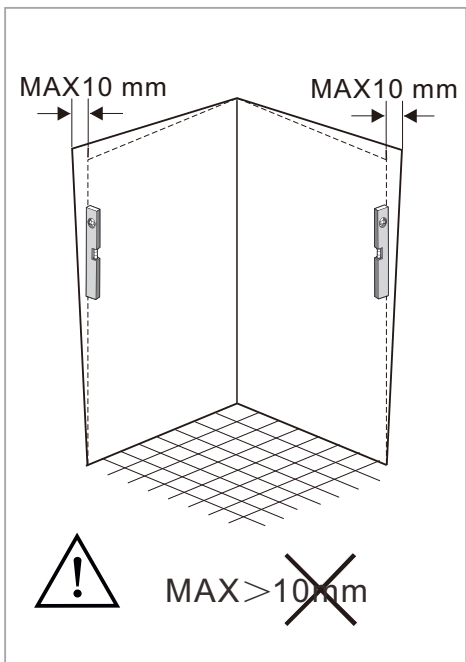
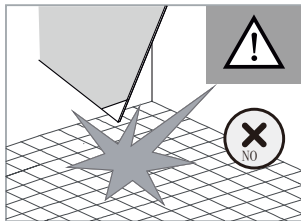
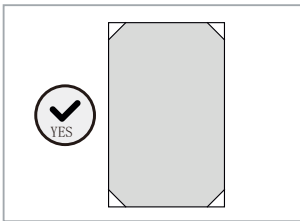
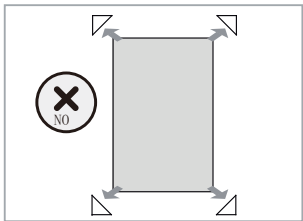
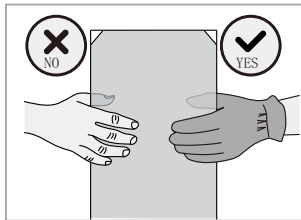
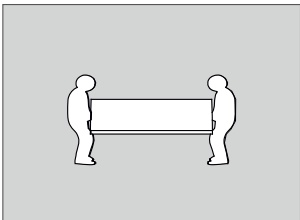
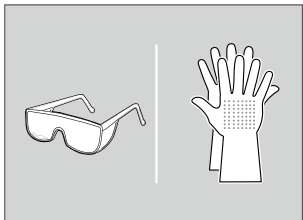
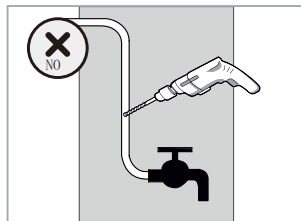
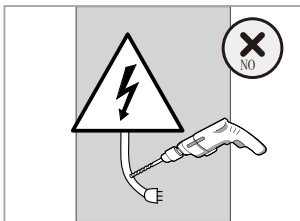
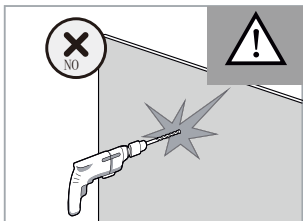

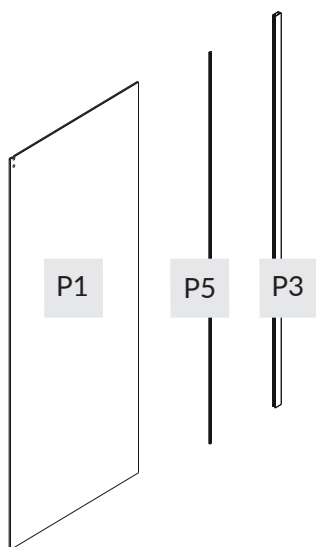
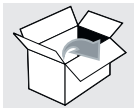



A



4x45

x4

B



x4

C



x4

R



x1

S



x2

T



x1

U1



x1

U2



x1

V



x2

W



x1

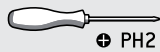
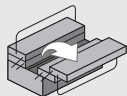



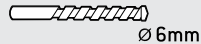



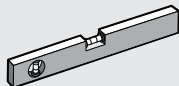
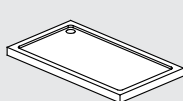
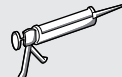
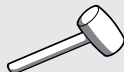

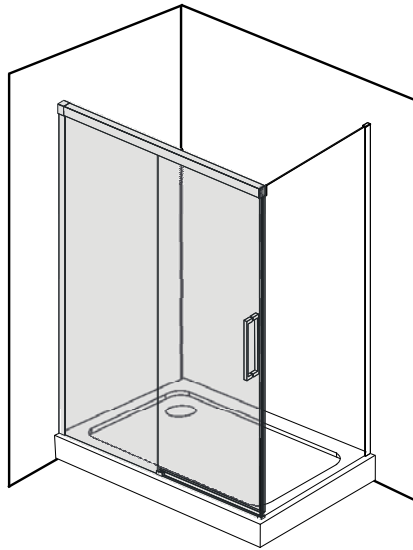
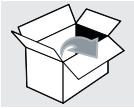

















PH2



Ø 6mm





- |   |  |  |  |   |  |   |
|---|--|--|--|---|--|---|
| <b>A</b><br><br>4x45<br>x8 | <b>B</b><br><br>x8    | <b>C</b><br><br>x4              | <b>D</b><br><br>x1    | <b>E</b><br><br>x1           | <b>F</b><br><br>x1            |   |
| <b>G</b><br><br>x1       | <b>H</b><br><br>x1  | <b>I</b><br><br>x1            | <b>J</b><br><br>x1  | <b>K</b><br><br>x1         | <b>L</b><br><br>x1          |   |
| <b>M1</b><br><br>x1      | <b>M2</b><br><br>x1 | <b>P</b><br><br>3.5x 12<br>x4 | <b>N</b><br><br>x1  | <b>F1</b><br><br>1mm<br>x4 | <b>F2</b><br><br>2mm<br>x4  | <b>F3</b><br><br>3mm<br>x4 |
| <b>L1</b><br><br>x1      | <b>L2</b><br><br>x1 | <b>Q1</b><br><br>x1           | <b>Q2</b><br><br>x1 | <b>R</b><br><br>x1         | <b>S</b><br><br>Ø PH2<br>x1 |   |

1.

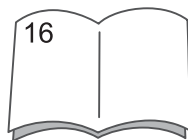
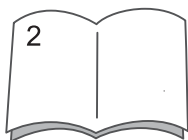
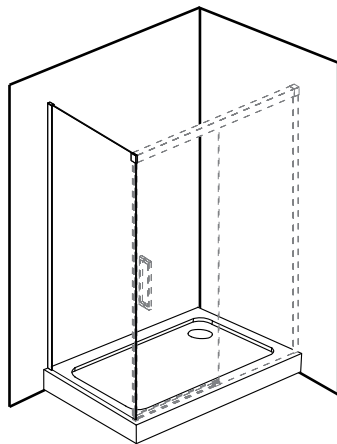
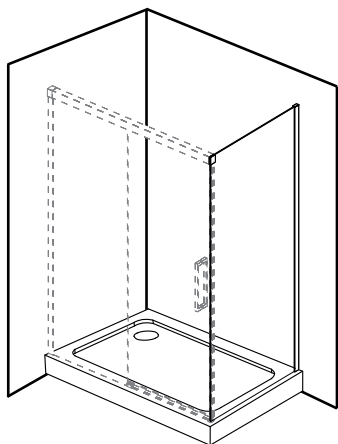

# 2.

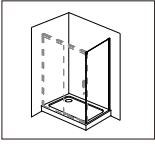

SIZE	X(mm)	Y(mm)
800X1200X2000	787	1195
900X1200X2000	887	1195
800X1400X2000	787	1395
900X1400X2000	887	1395

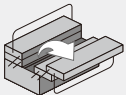
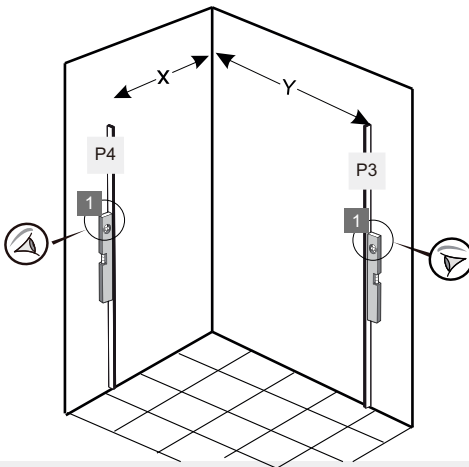
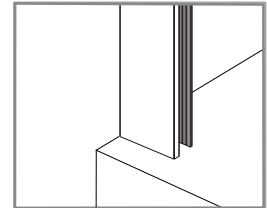
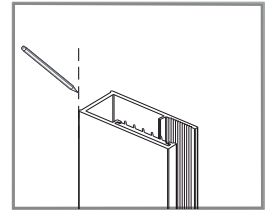
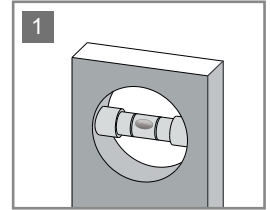
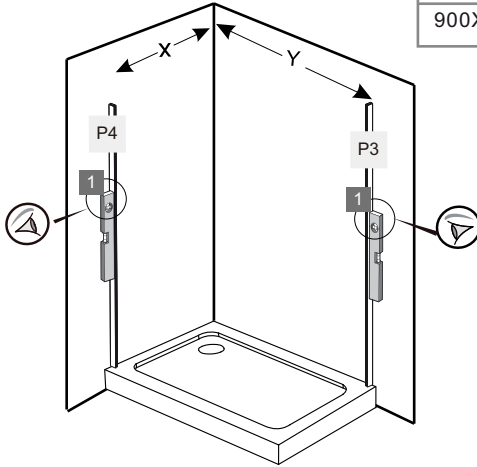

P4  x1

P3  x1



### 3.

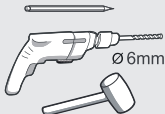
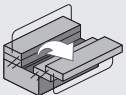
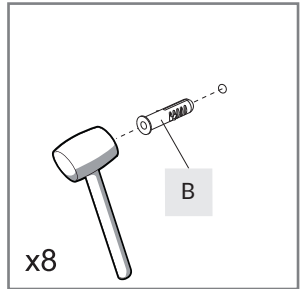
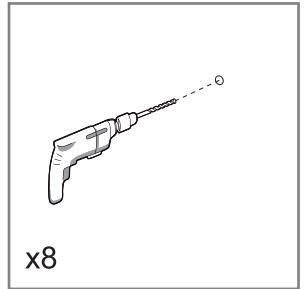
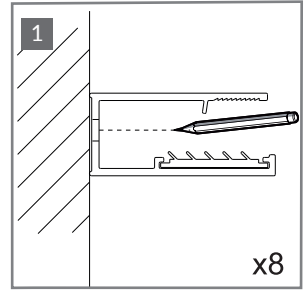
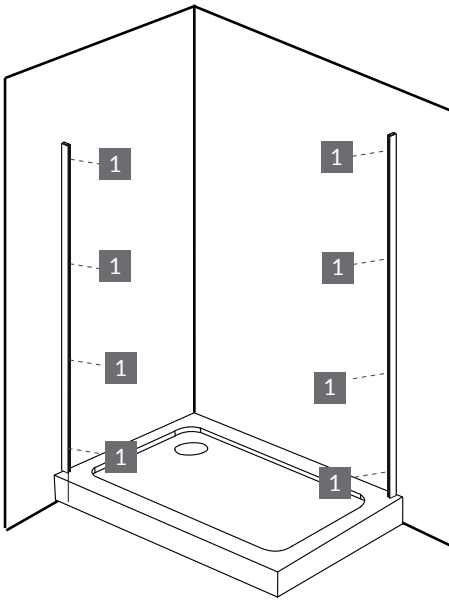
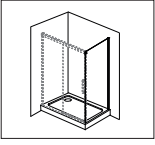

B





x8



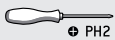
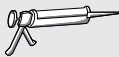
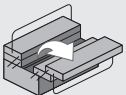
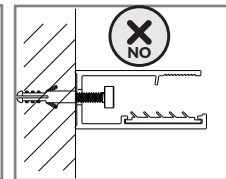
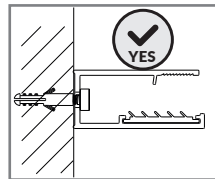
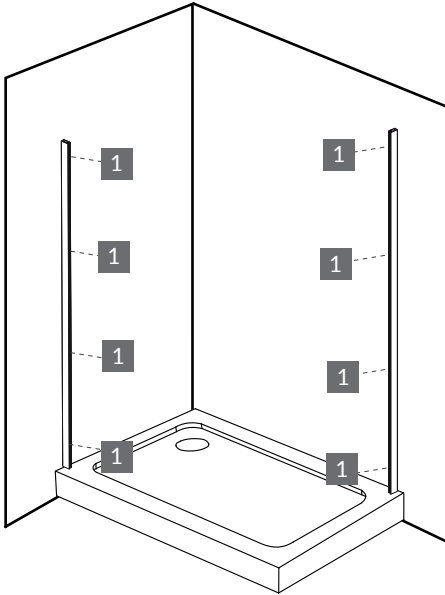
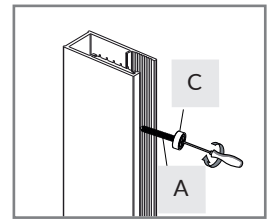
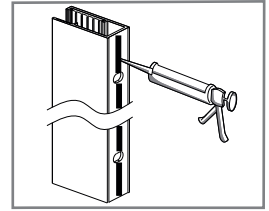
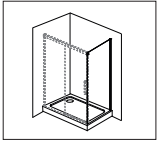

4.



P4  x1

P3  x1





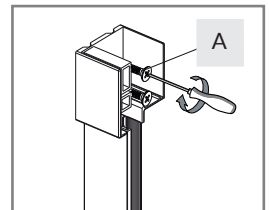
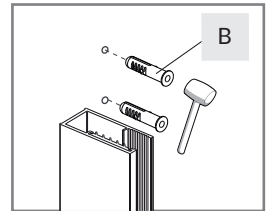
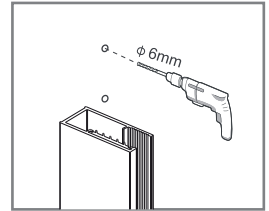
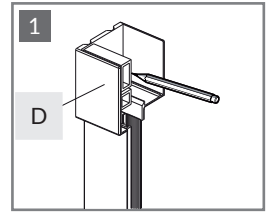
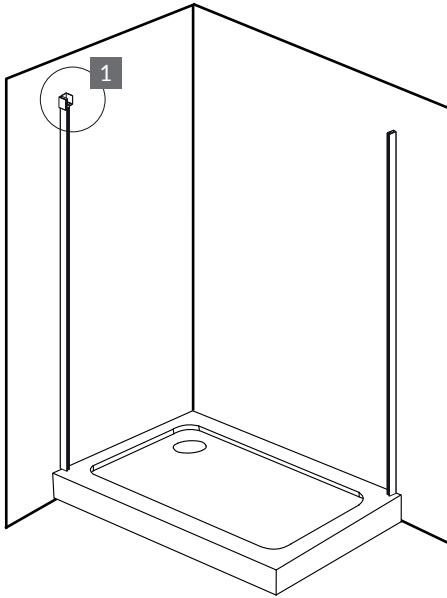
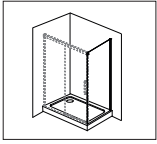

C  x8

A  x8  
4x45

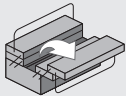

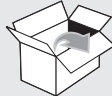
# 5.



		D		x1	
		B		x2	
		A		x2	

6.

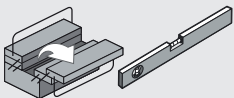
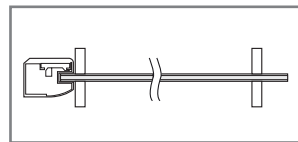
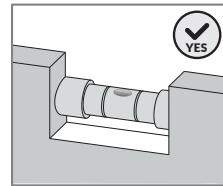
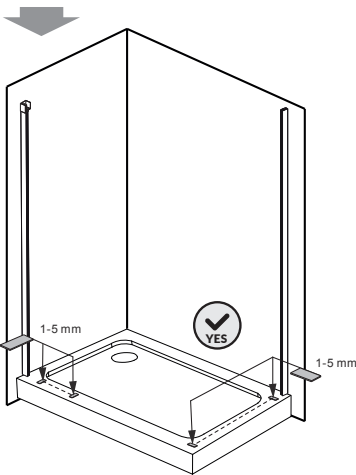
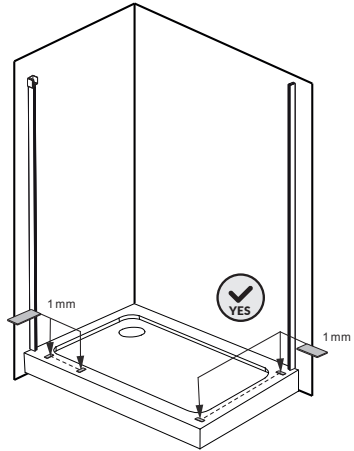
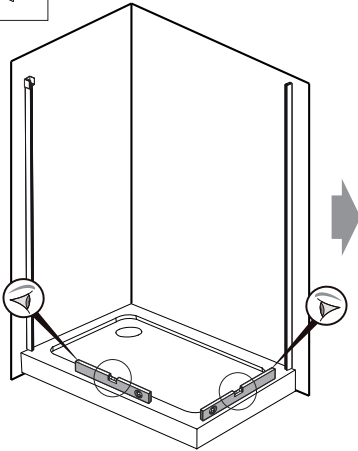
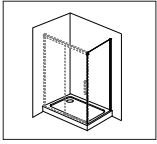

F1

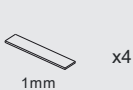

1mm

x4

F2

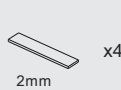

2mm

x4

F3



3mm

x4



# 7.

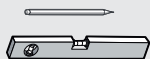
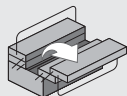
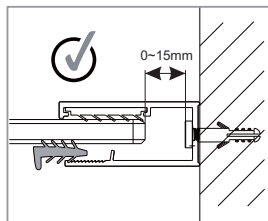
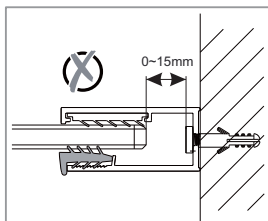
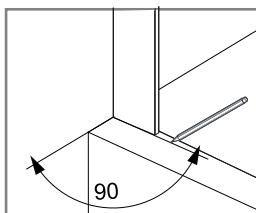
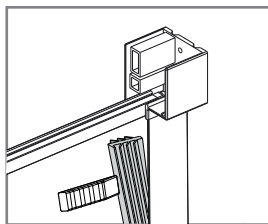
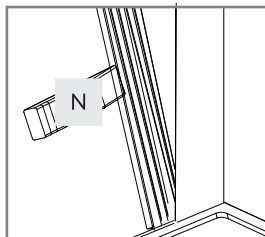
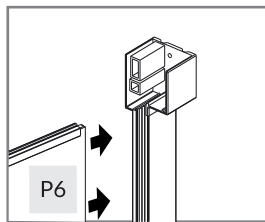
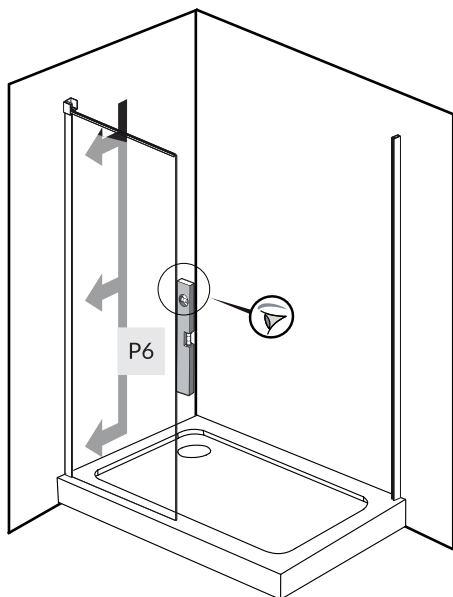
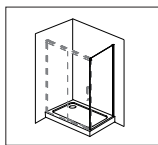

P5 ————— x1

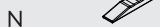

N



x1

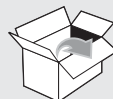

8.

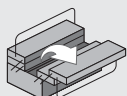
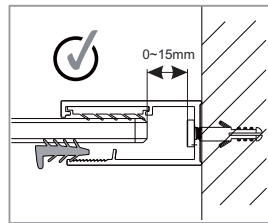
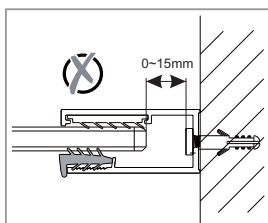
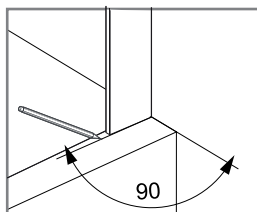
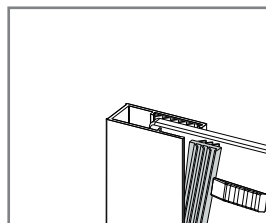
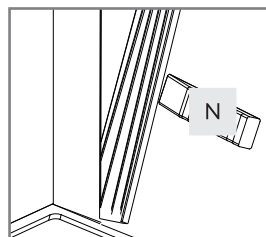
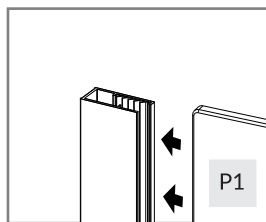
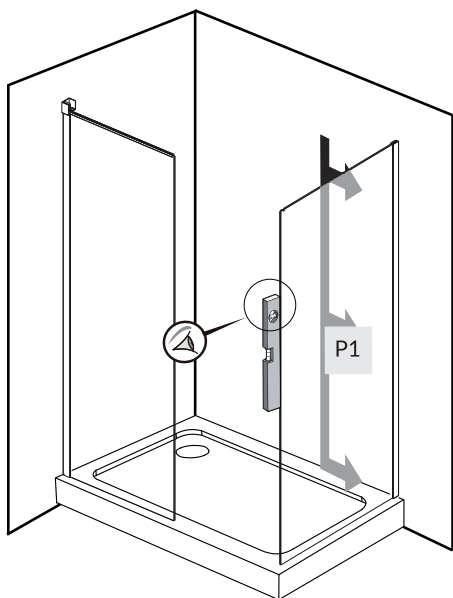
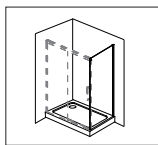

P5



x1

N



x1



# 9.

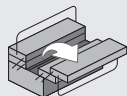
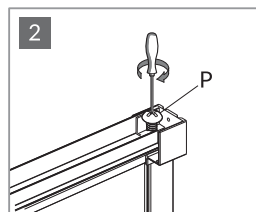
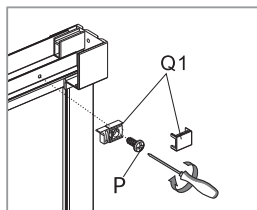
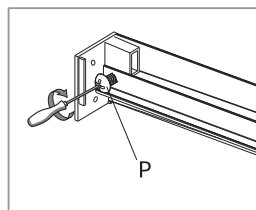
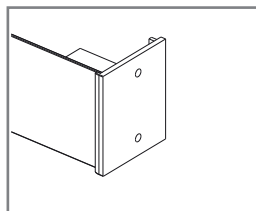
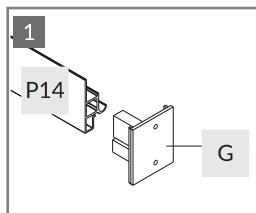
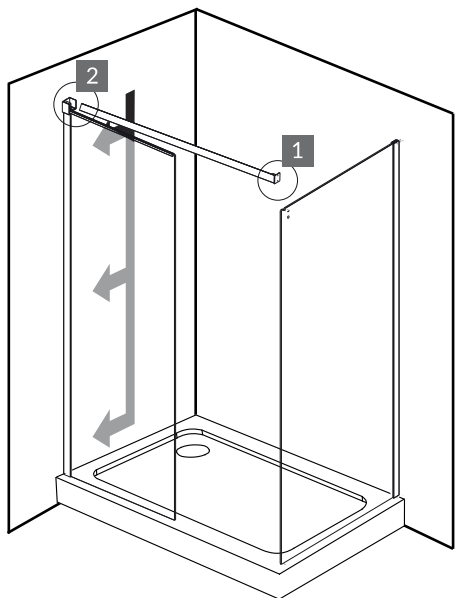
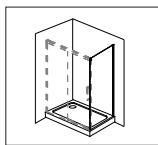

G  x1

Q1  x1



S  x1

P  3.5x12 x3

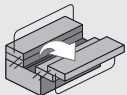
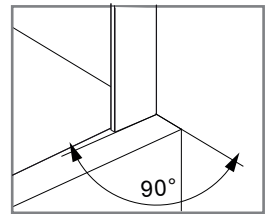
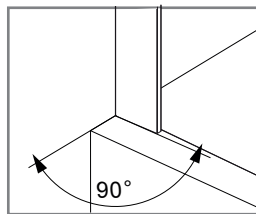
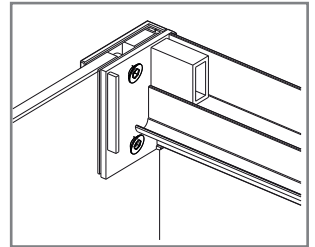
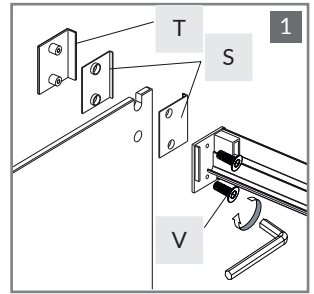
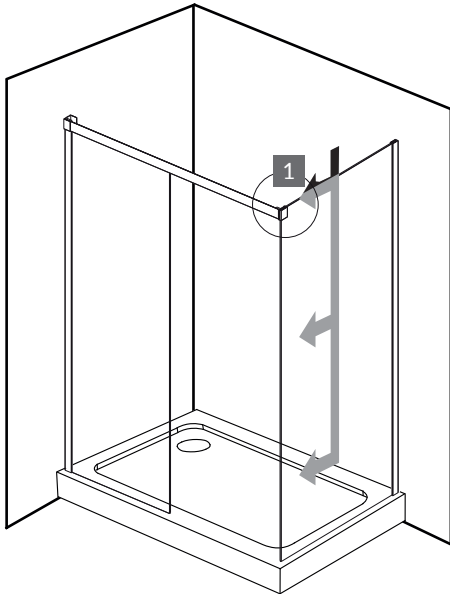
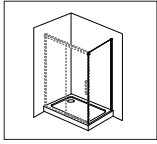

# 10.



- S  x2
- T  x1
- V  x2



# 11.

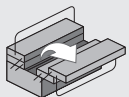
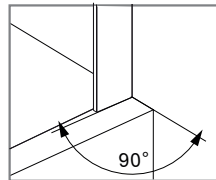
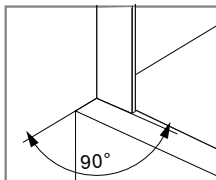
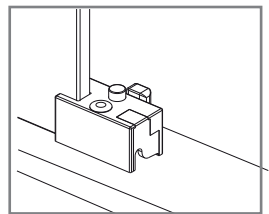
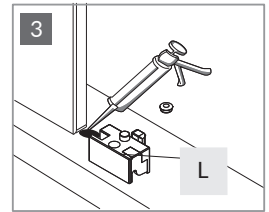
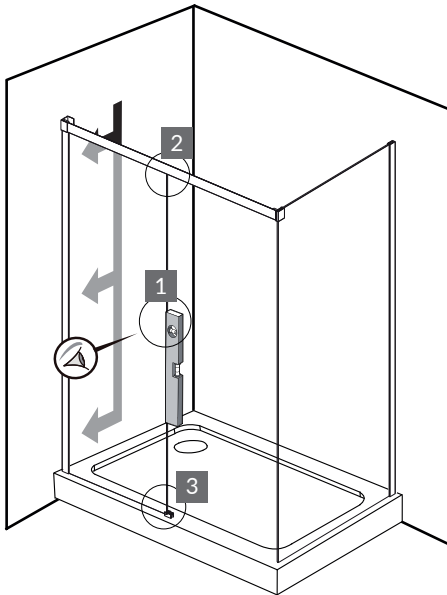
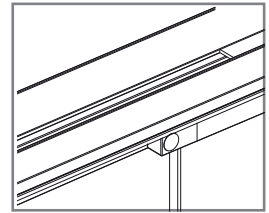
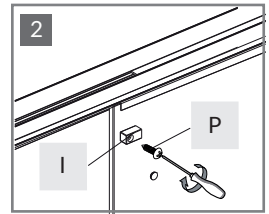
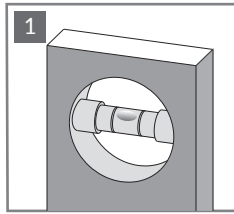
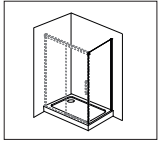

L



x1

I



x1

P



x1





# 12.

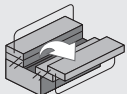
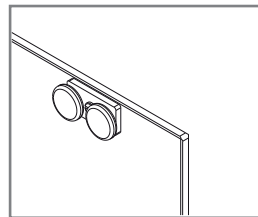
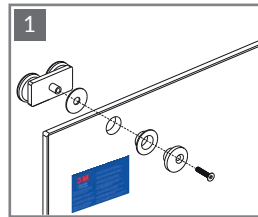
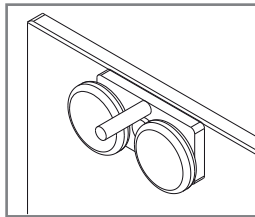
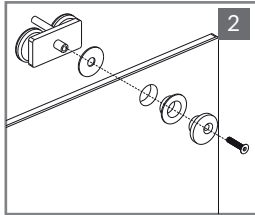
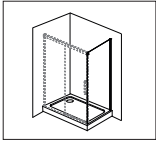





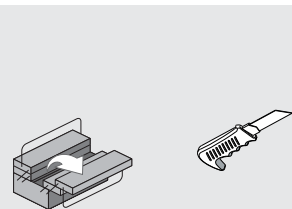
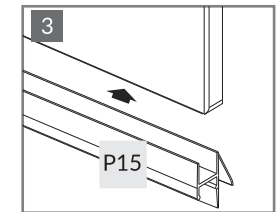
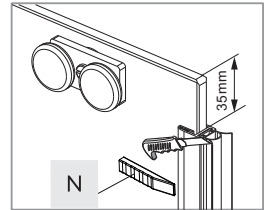
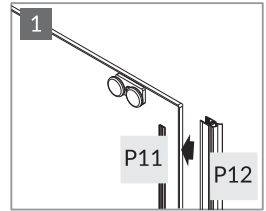
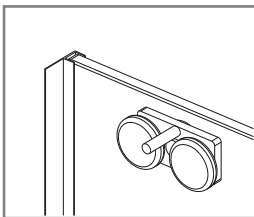
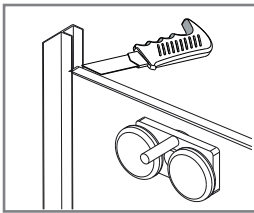
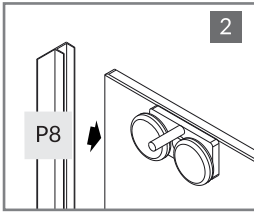
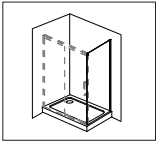

J  x1

K  x1



# 13.



- P12  x1
- P11  x1
- P8  x1
- P15  x1
- N  x1



14.

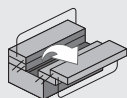
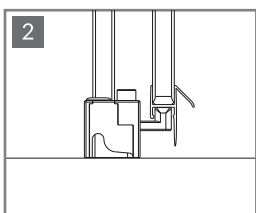
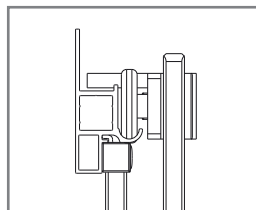
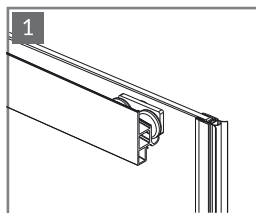
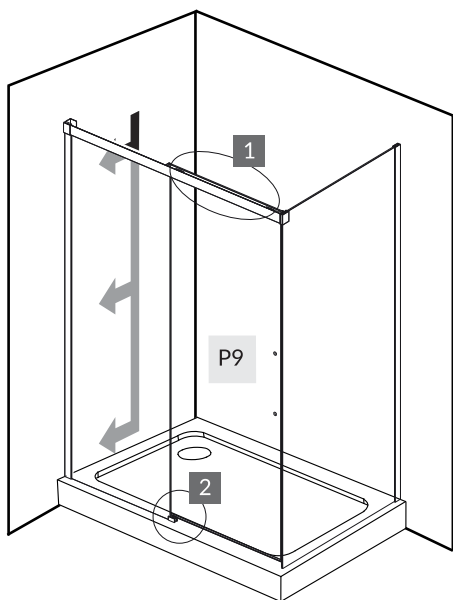
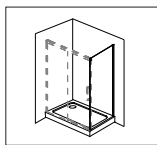

15.

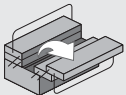
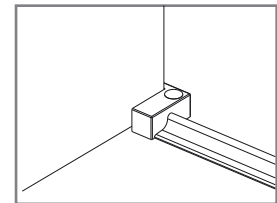
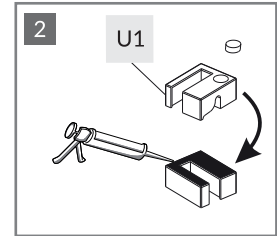
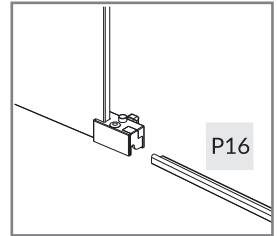
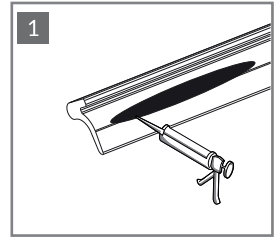
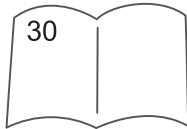
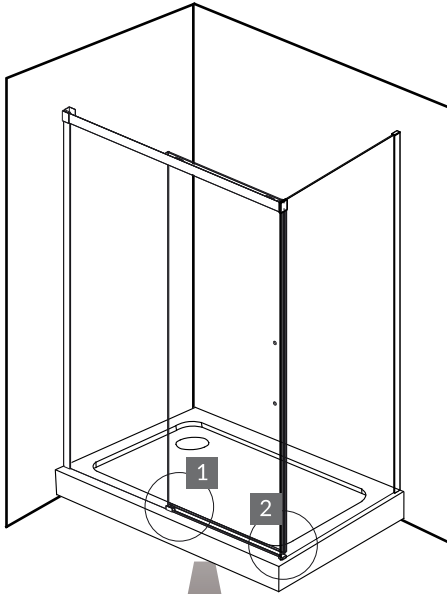
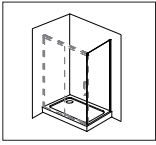

P16 ——— x1

U1  x1



16.

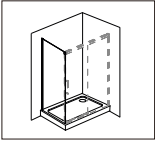

SIZE	X(mm)	Y(mm)
800X1200X2000	787	1195
900X1200X2000	887	1195
800X1400X2000	787	1395
900X1400X2000	887	1395

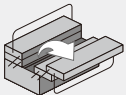
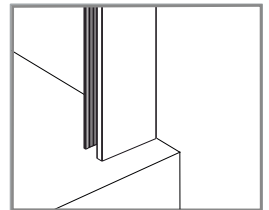
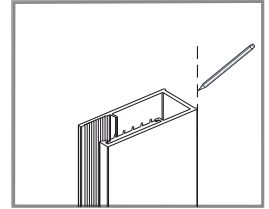
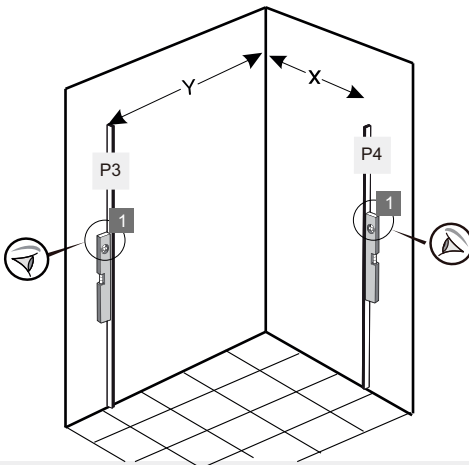
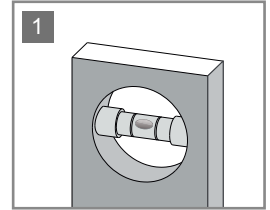
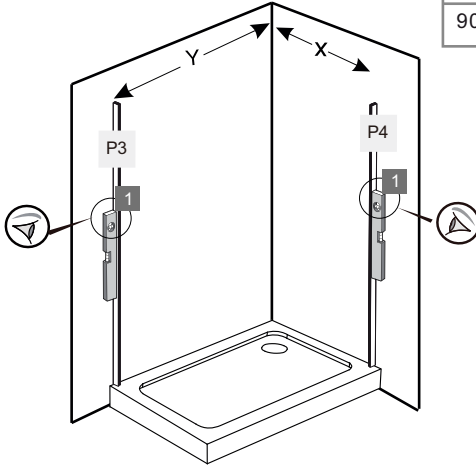

P4  x1

P3  x1



17.

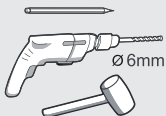
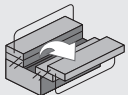
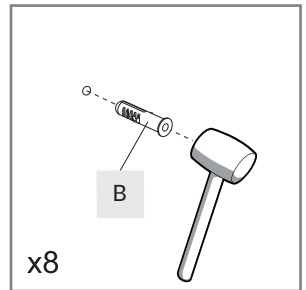
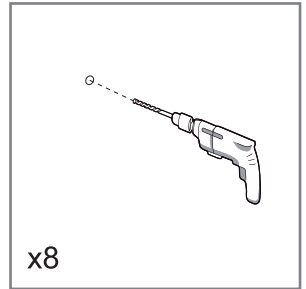
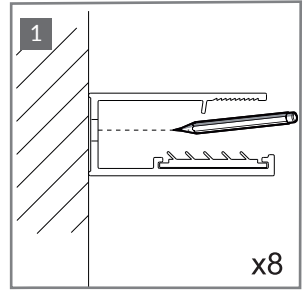
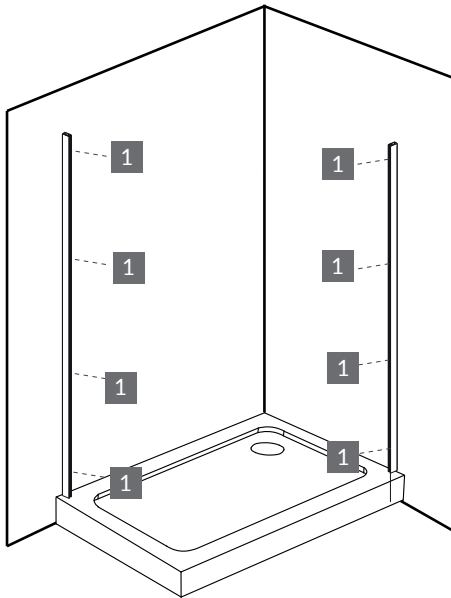
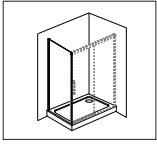

B



x8



18.

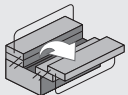
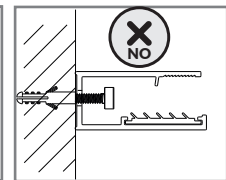
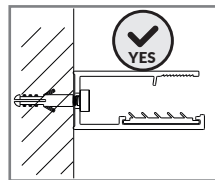
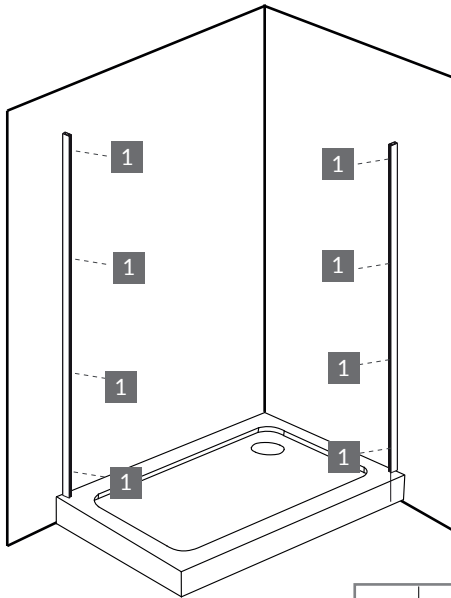
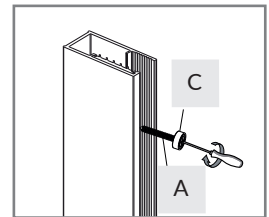
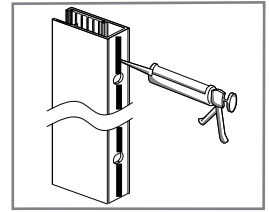
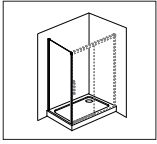

P4



x1

P3



x1

C

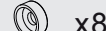

x8

A



x8



# 19.

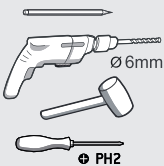
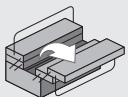
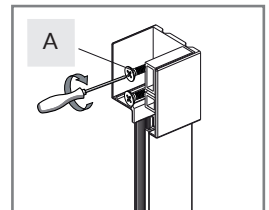
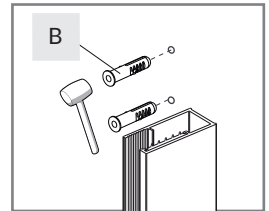
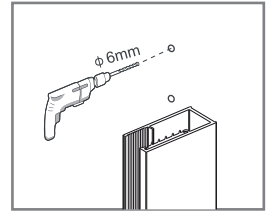
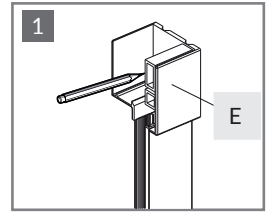
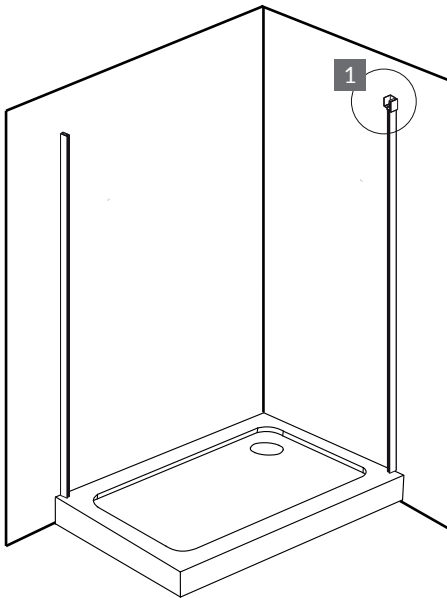
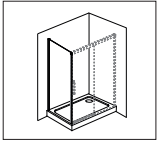

E



x1

B



x2

A



x2





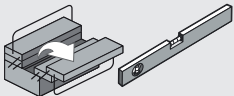
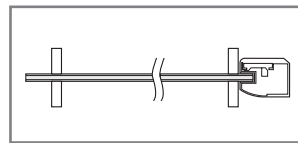
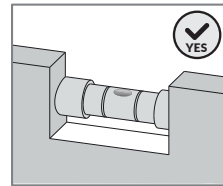
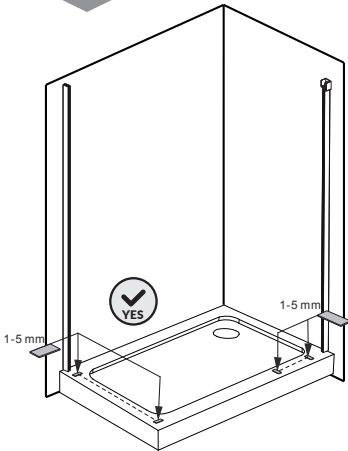
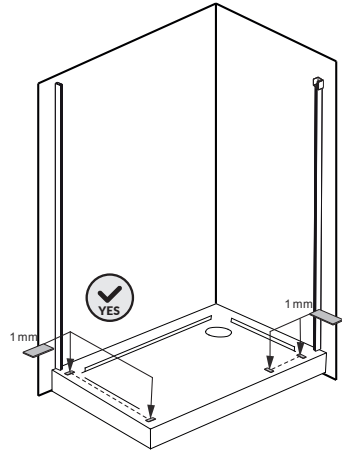
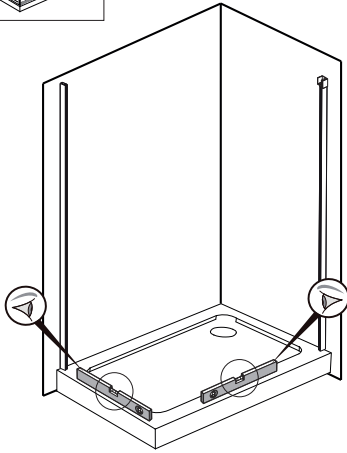
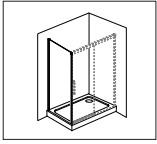

F1

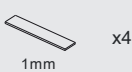

x4

F2



x4

F3



x4



21.

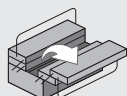
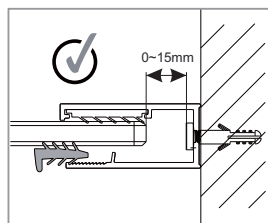
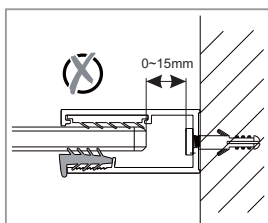
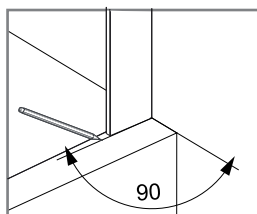
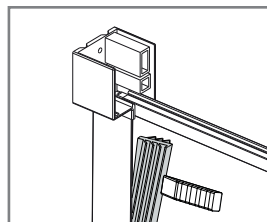
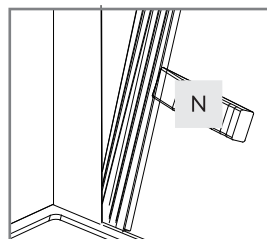
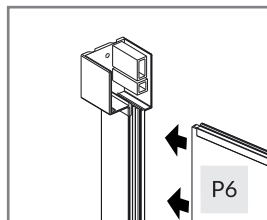
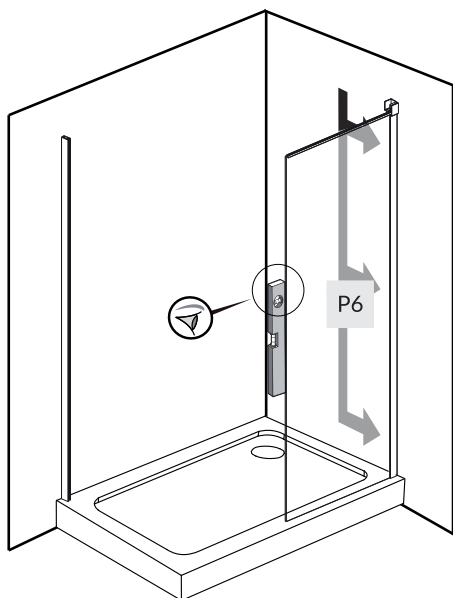
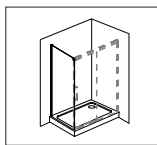

P5 ————— x1

N ————— x1



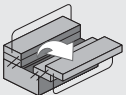
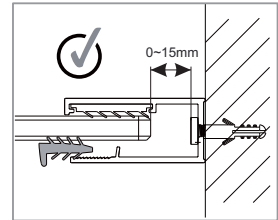
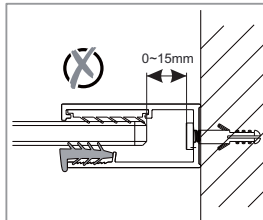
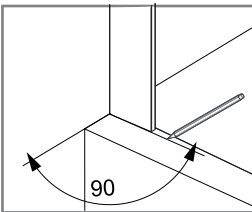
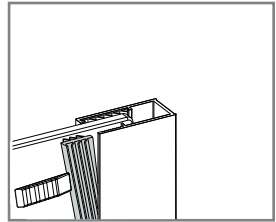
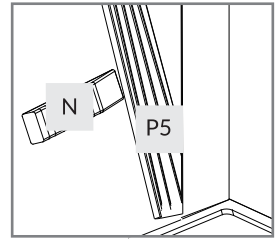
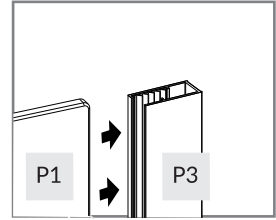
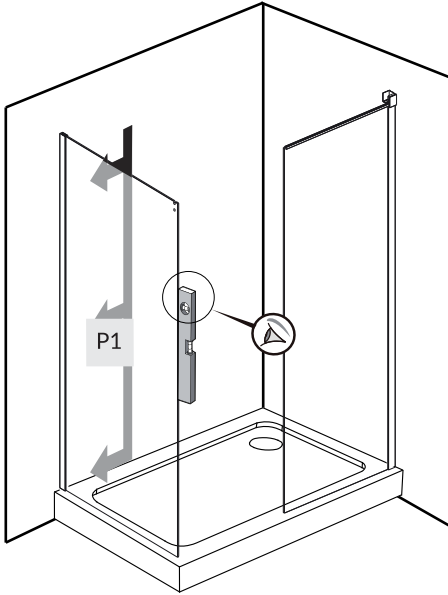
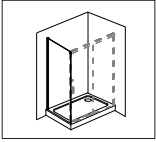

P5



x1

N





x1

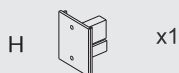
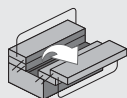
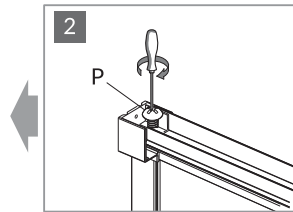
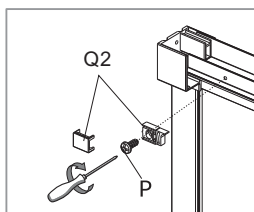
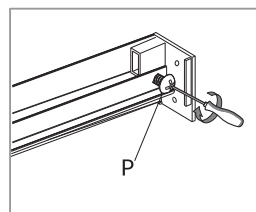
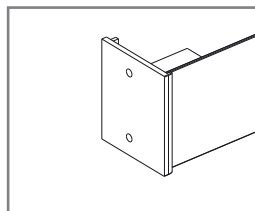
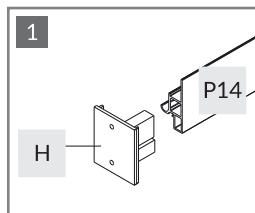
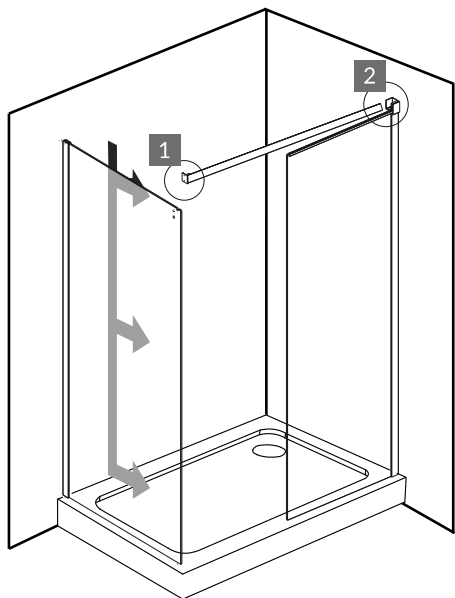
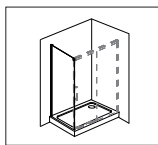

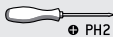
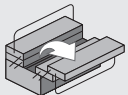
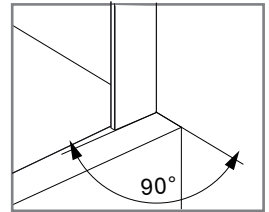
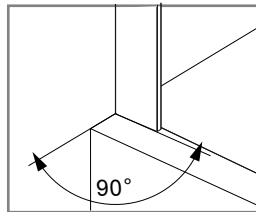
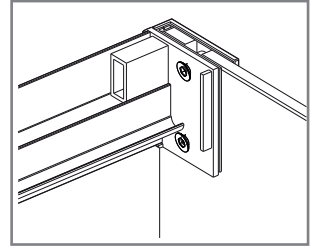
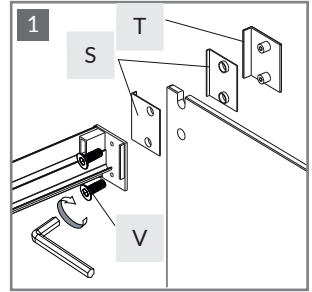
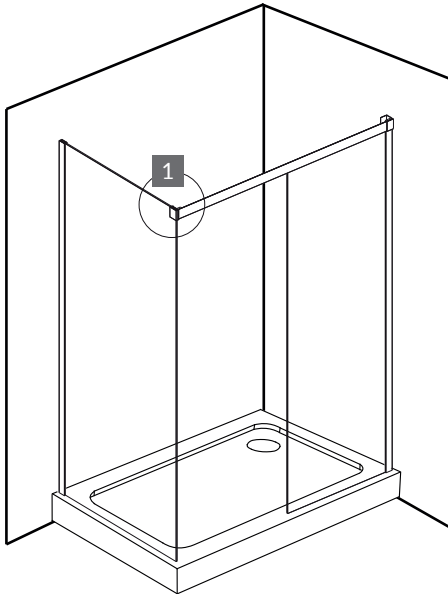
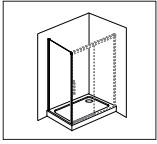



- S  x2
- T  x1
- V  x2



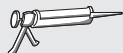
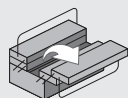
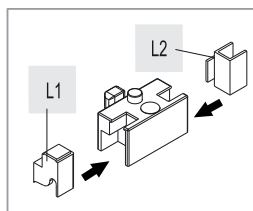
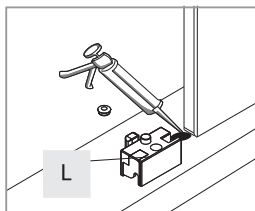
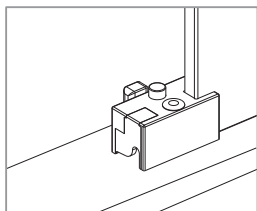
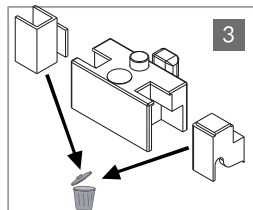
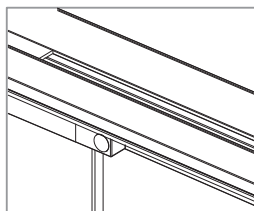
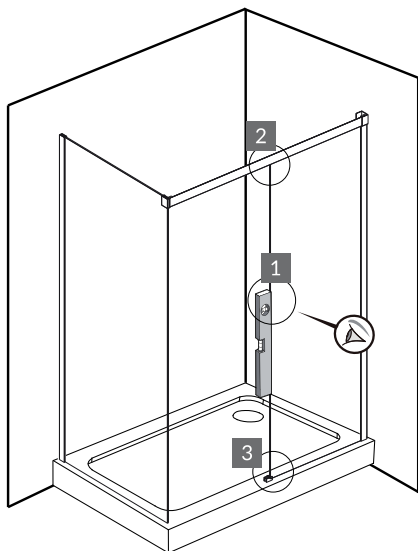
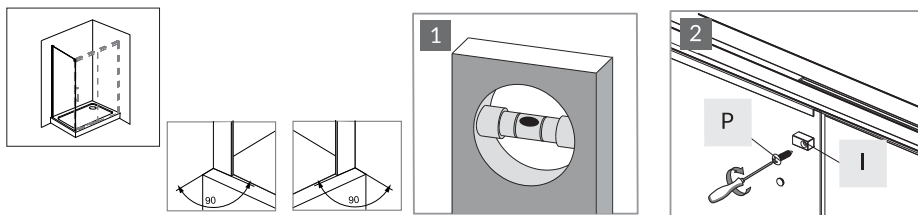

L x1



I x1



L1



L2

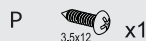

P 3.5x12 x1



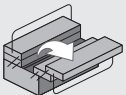
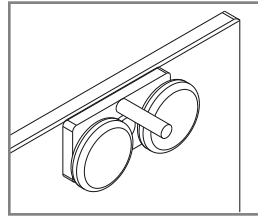
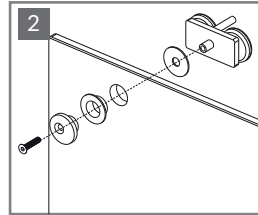
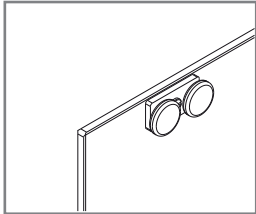
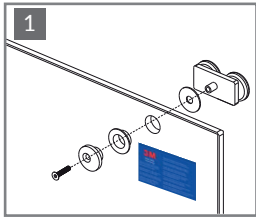
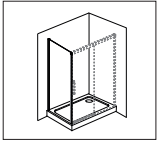

J



x1

K



x1



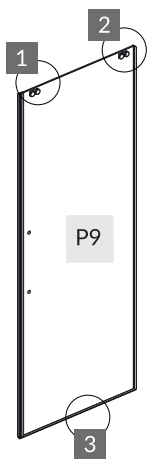
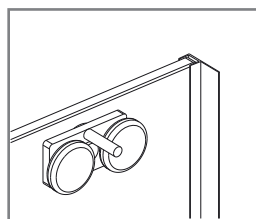
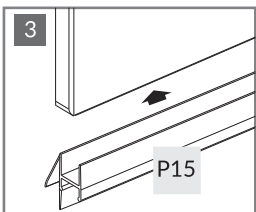
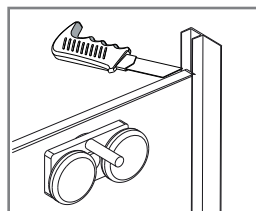
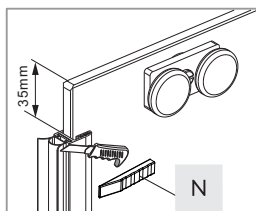
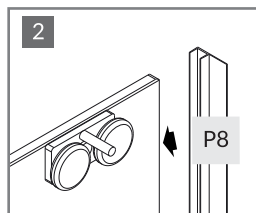
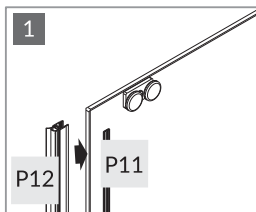
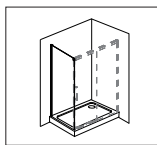

	P12		x1	
	P11		x1	
	P8		x1	
	P15		x1	
	N		x1	



28.

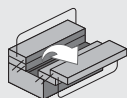
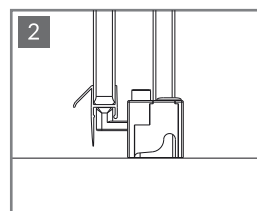
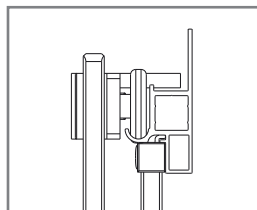
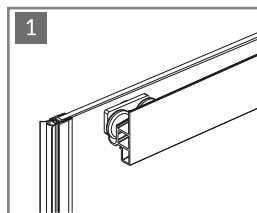
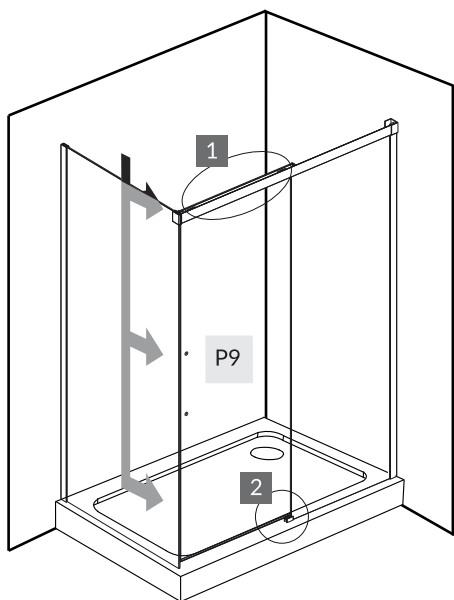
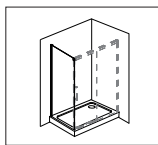

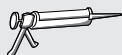
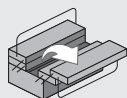
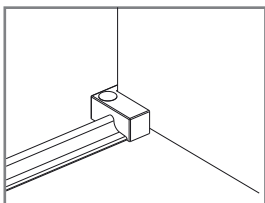
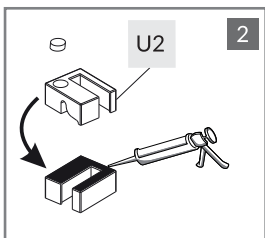
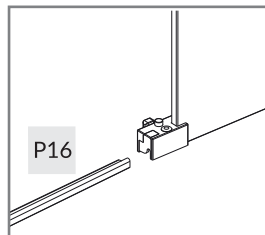
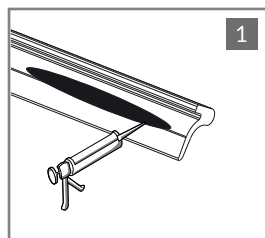
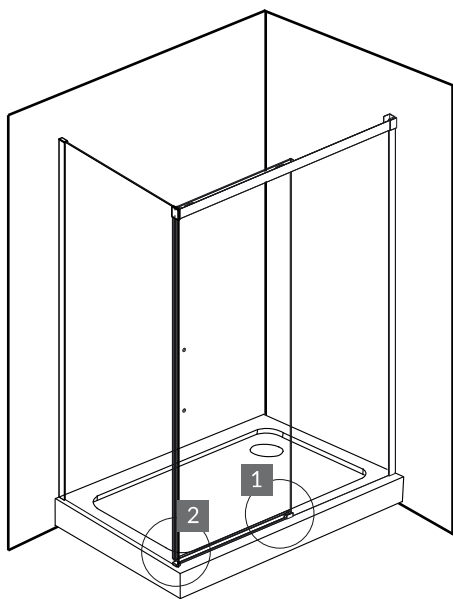
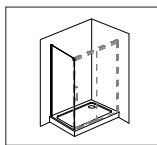

P16 ————— x1

U2  x1



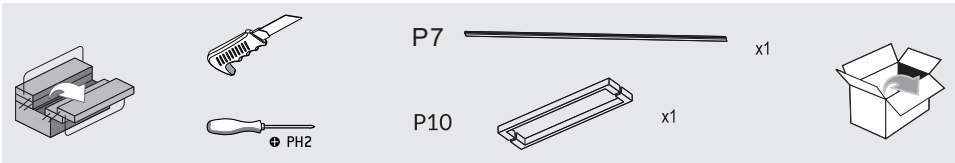
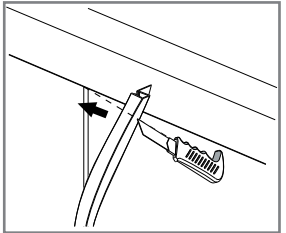
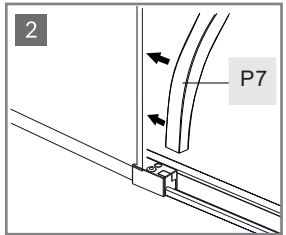
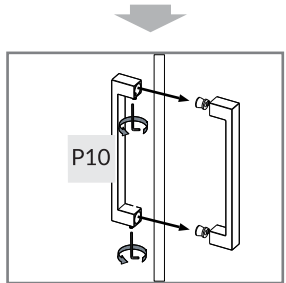
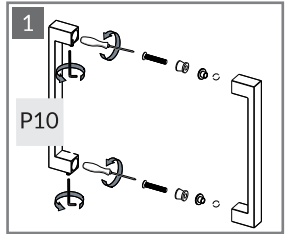
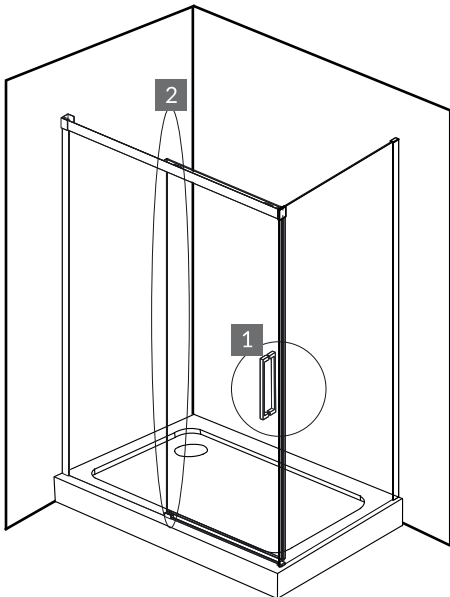

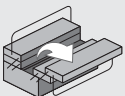
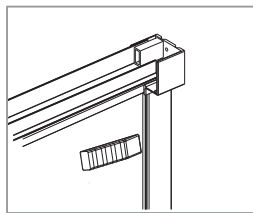
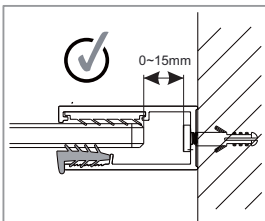
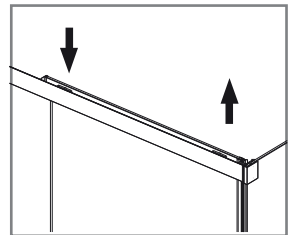
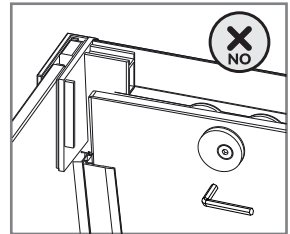
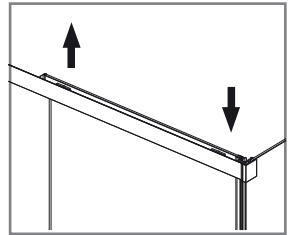
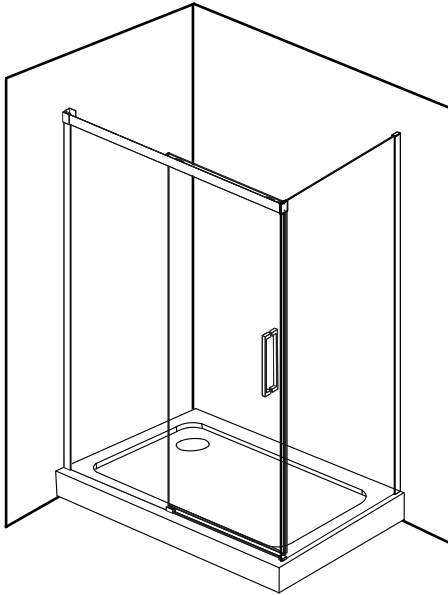
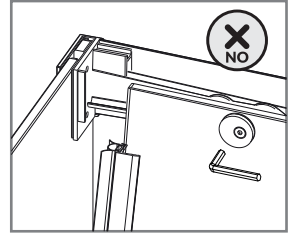
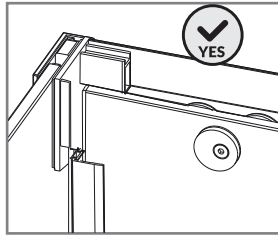

R  x1

N  x1



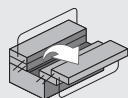
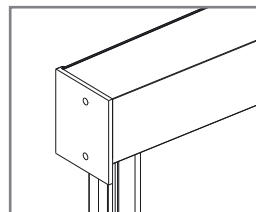
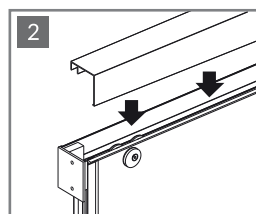
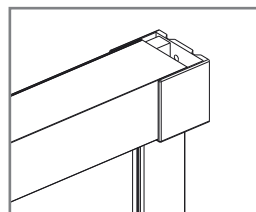
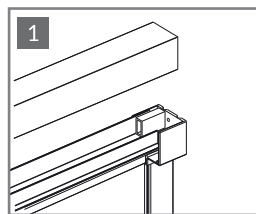
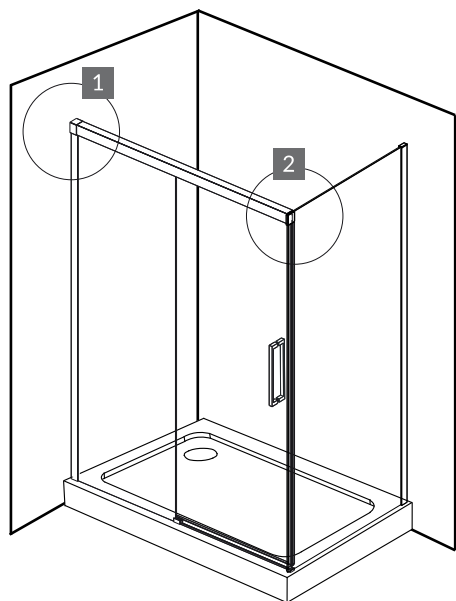

P13



x1



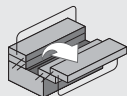
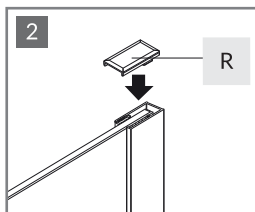
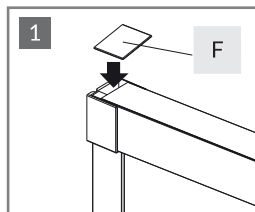
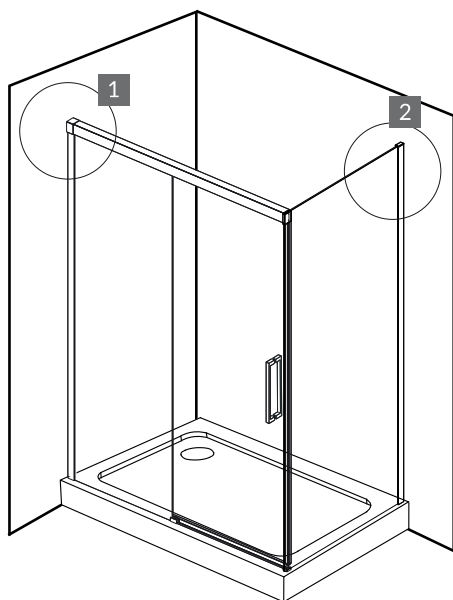

R  x1

F  x1



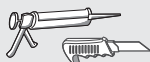
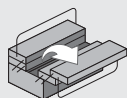
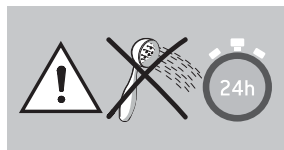
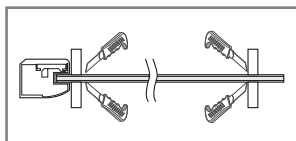
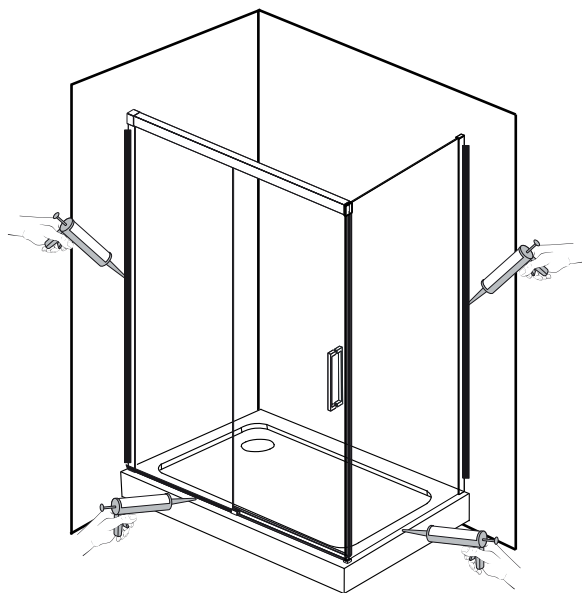



6.5 < PH < 7.5

