

# CREA

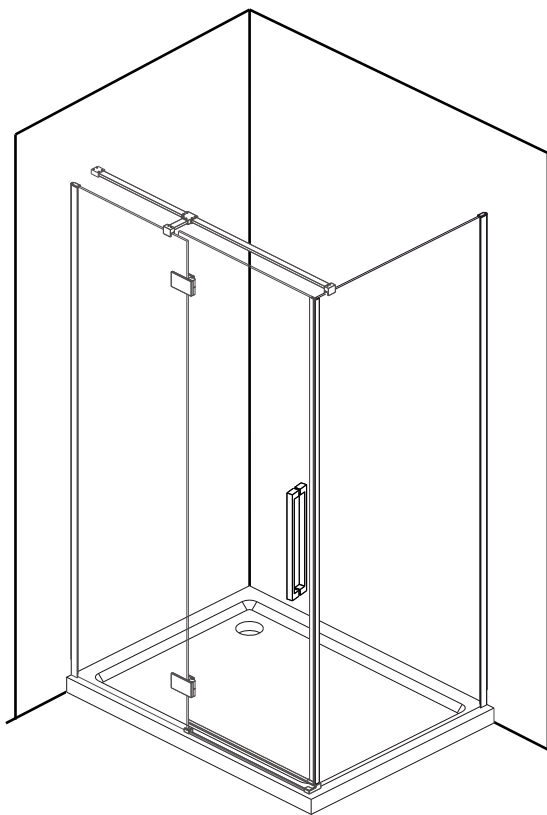

PL INSTRUKCJA MONTAŻU I EKSPLOATACJI

CZ NÁVOD NA MONTÁŽ A ÚDRŽBU

SK NÁVOD NA MONTÁŽ A ÚDRŽBU

EST PAIGALDUS- JA KASUTUSJUHEND

LT MONTAVIMO IR EKSPLOATAVIMO INSTRUKCIJA

LV MONTĀŽAS UN EKSPLUATĀCIJAS INSTRUKCIJA

DE MONTAGE- UND AUFBAUANLEITUNG

RO INSTRUCȚIUNI DE MONTAJ ȘI OPERARE

HU SZERELÉSI ÉS ÜZEMELTETÉSI ÚTMUTATÓ

UA ІНСТРУКЦІЯ З МОНТАЖУ І ЕКСПЛУАТАЦІЇ

BY ІНСТРУКЦЫЯ ПА МАНТАЖЫ І ЭКСПЛУАТАЦЫІ

RU ИНСТРУКЦИЯ ПО МОНТАЖУ И ЭКСПЛУАТАЦИИ

EN INSTRUCTIONS FOR ASSEMBLY AND USE

FR INSTALLATION ET UTILISATION - MODE

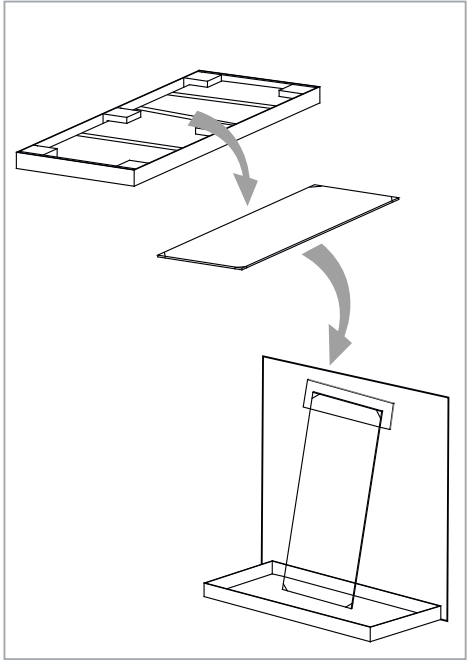
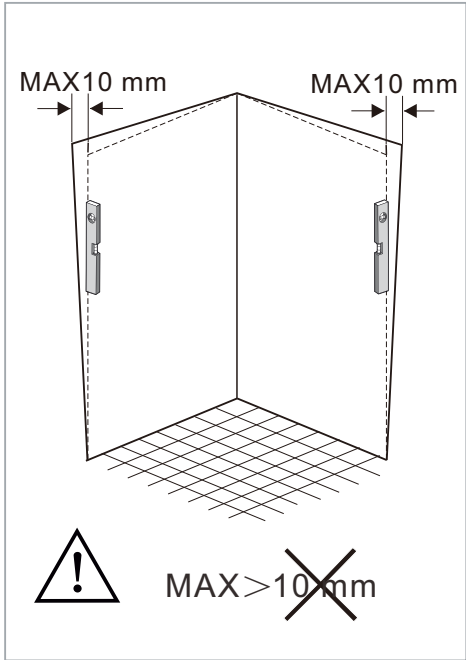
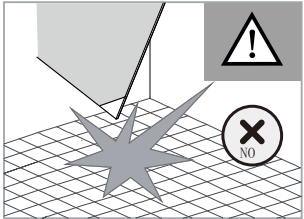
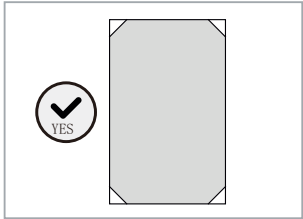
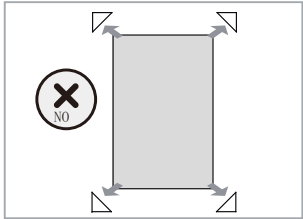
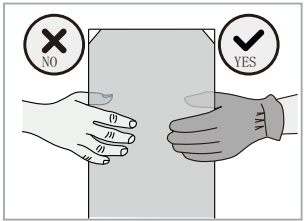
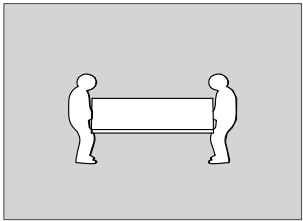
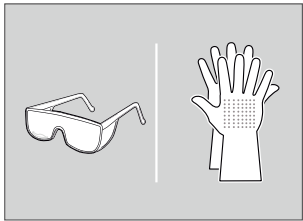
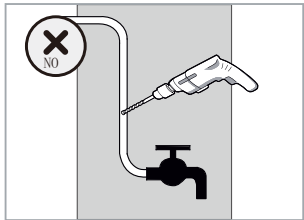
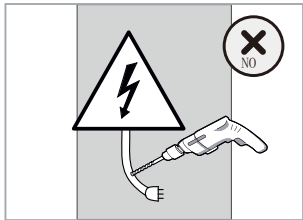
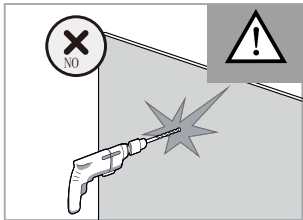



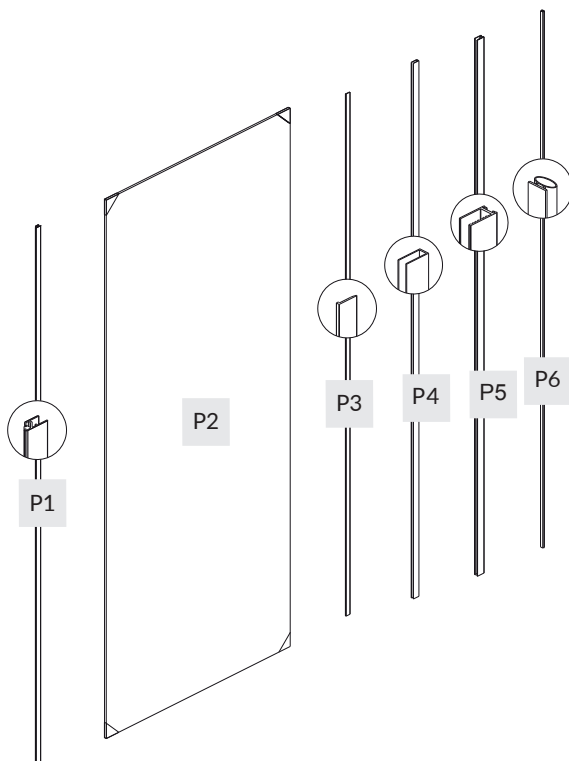
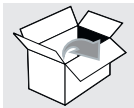

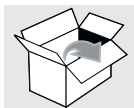

L1



x1

L2



x1

J



x1

D



x1

F1



1mm

x4

F2



2mm

x4

F3



3mm

x4

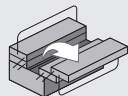

PH2

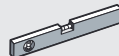

Ø 6mm

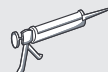
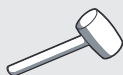

Ø 3mm

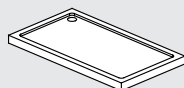

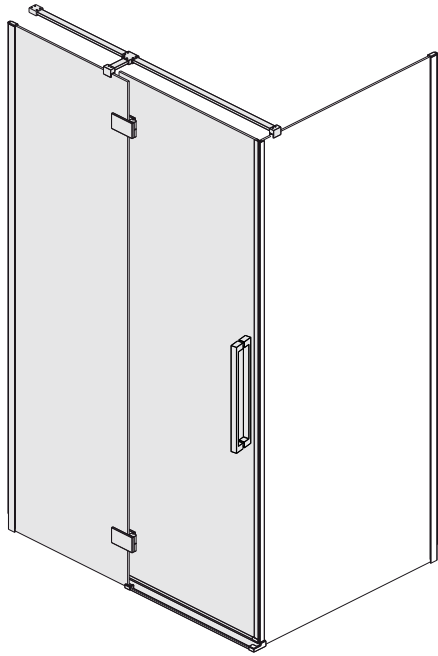
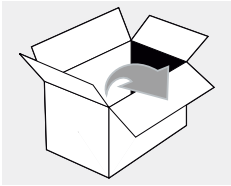

A



4X35

x8

B



x8

I1



x1

I2



x1

J



x1

K1



x1

K2



x1

L



x1

M

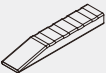

x1

F1



1mm

x4

F2



2mm

x4

F3



3mm

x4

N



2mm

x1

1.

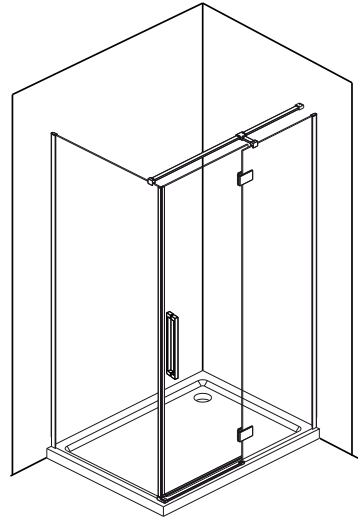
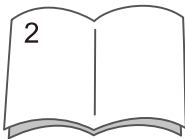
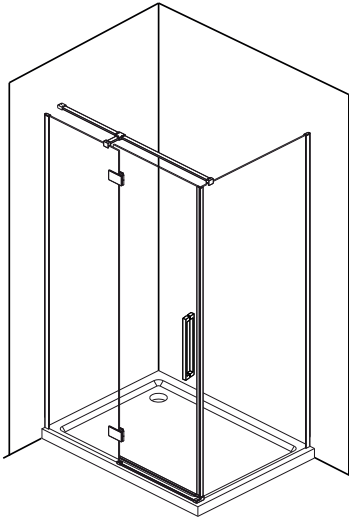

# 2.

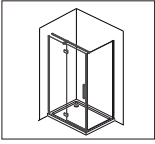

SIZE	X (mm)	Y (mm)
800 X 900 X 2000	793	893
800 X 1000 X 2000	793	993
800 X 1200 X 2000	793	1193
900 X 900 X 2000	893	893
900 X 1000 X 2000	893	993
900 X 1200 X 2000	893	1193

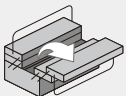
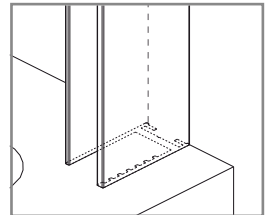
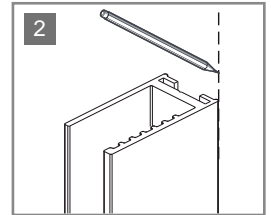
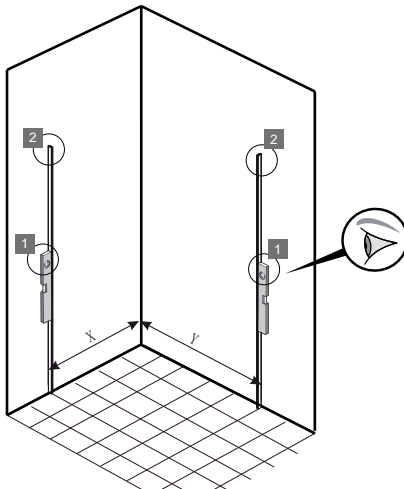
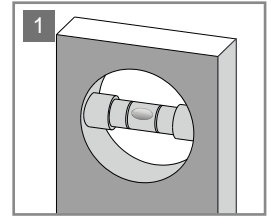
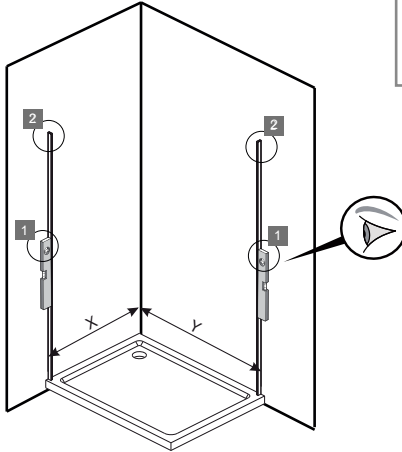

P5



x2



### 3.

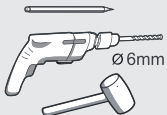
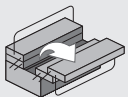
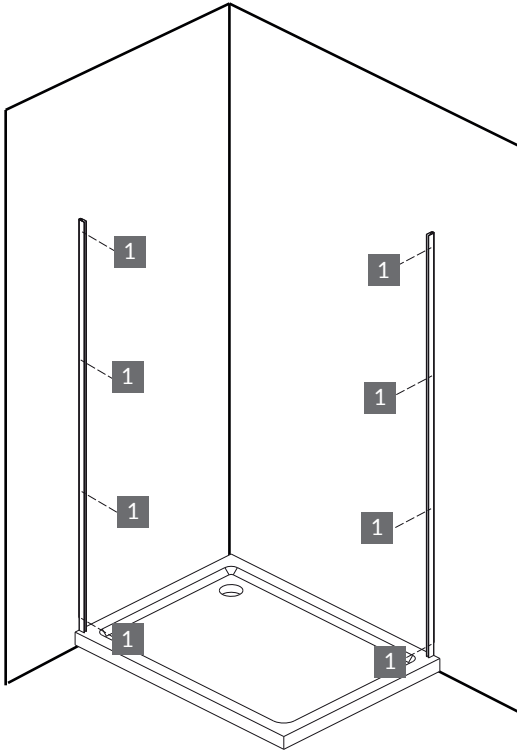
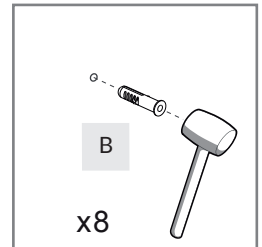
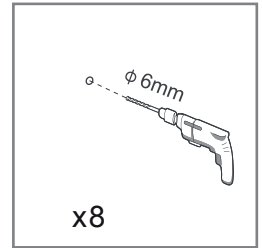
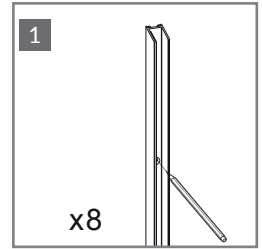
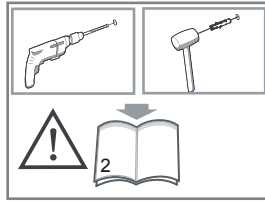
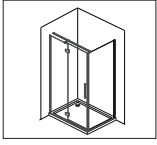

B



x8



# 4.

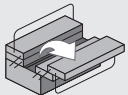
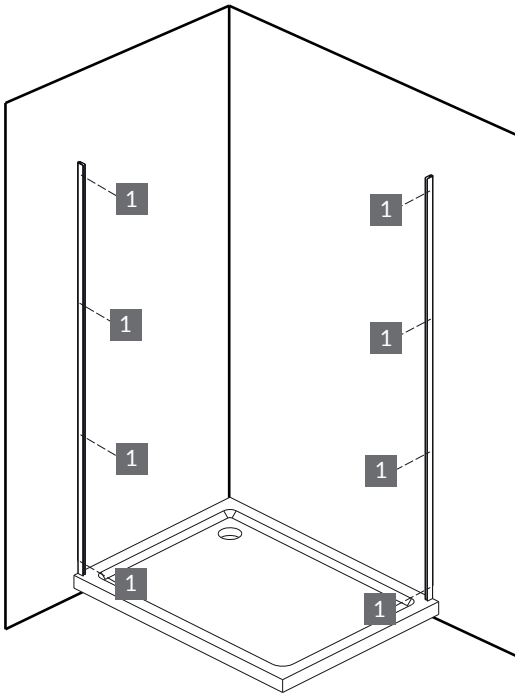
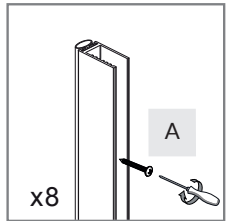
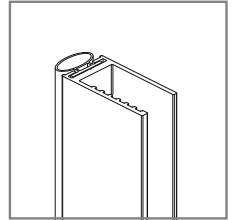
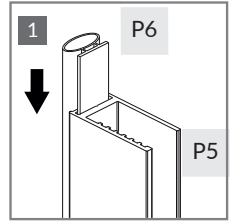
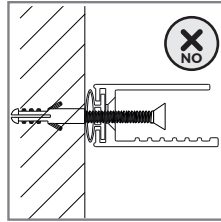
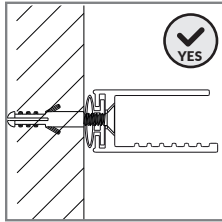
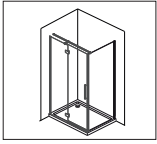

P6 ————— x2

P5 ————— x2

A  x8  
4X35



# 5.

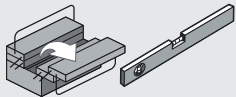
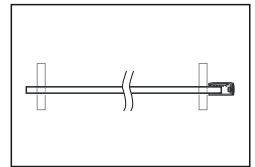
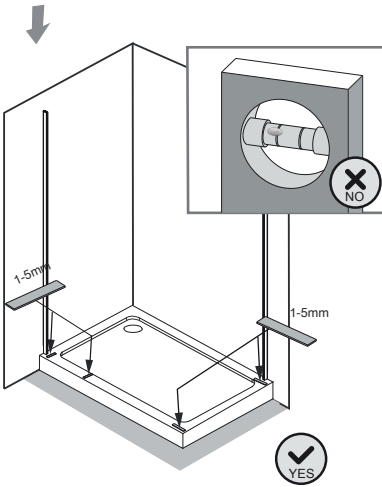
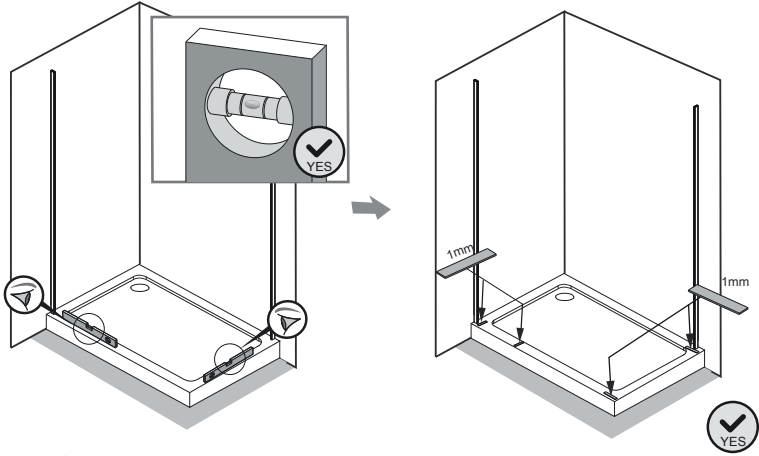
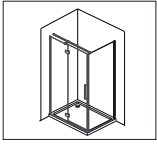

F1



x4

F2



x4

F3



x4





# 6.

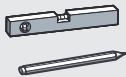
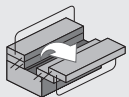
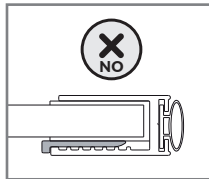
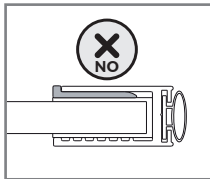
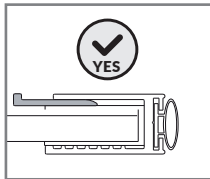
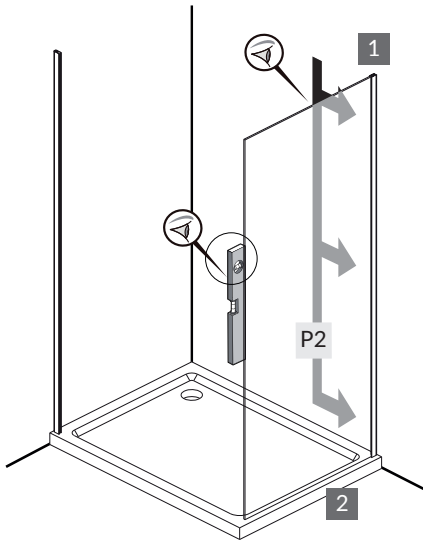
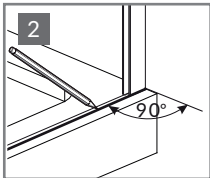
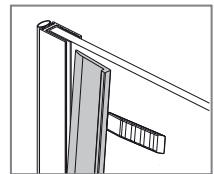
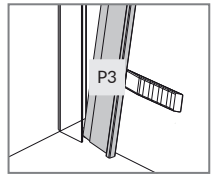
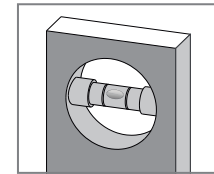
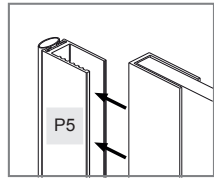
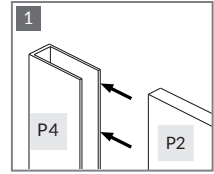
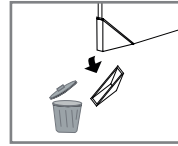
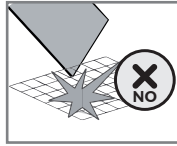
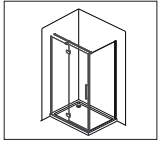

P4 ————— x1





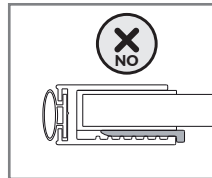
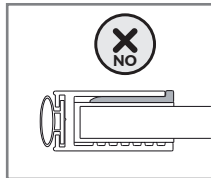
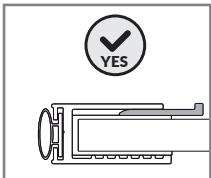
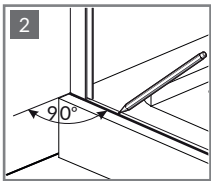
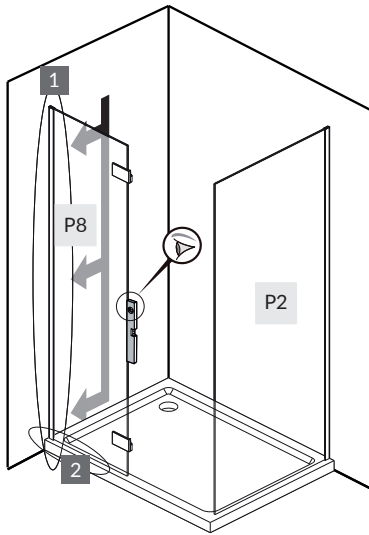
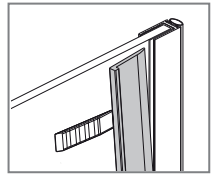
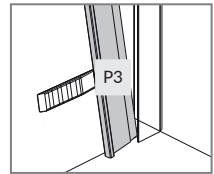
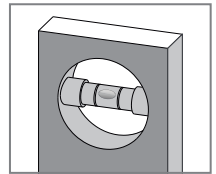
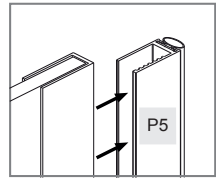
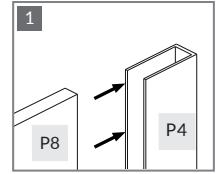
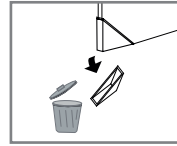
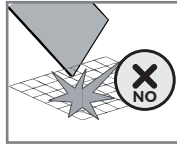
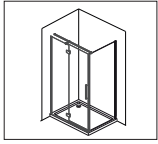

P3 ————— x1

M ————— x1

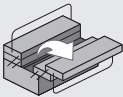

# 7.



			P4		x1	
			P3		x1	
			M		x1	

# 8.

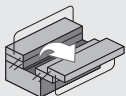
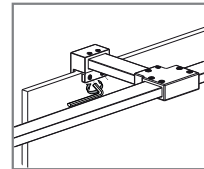
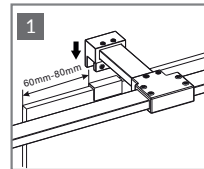
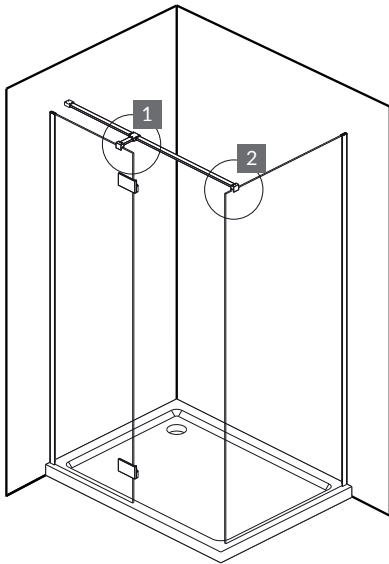
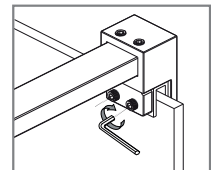
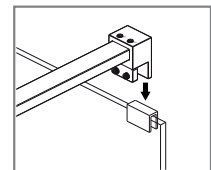
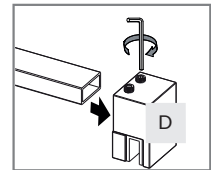
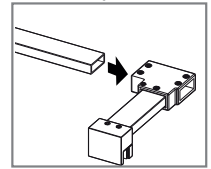
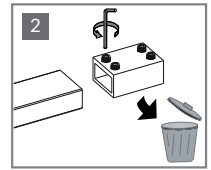
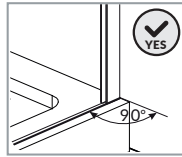
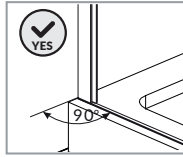
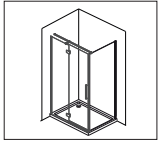

P9  x1

 x4

 x4

 x1

 x1

P10  x1

D  x1



# 9.

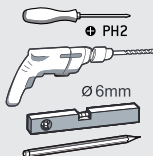
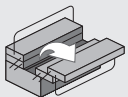
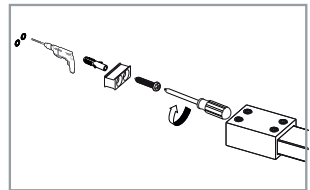
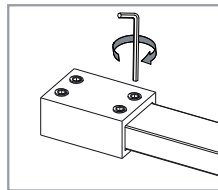
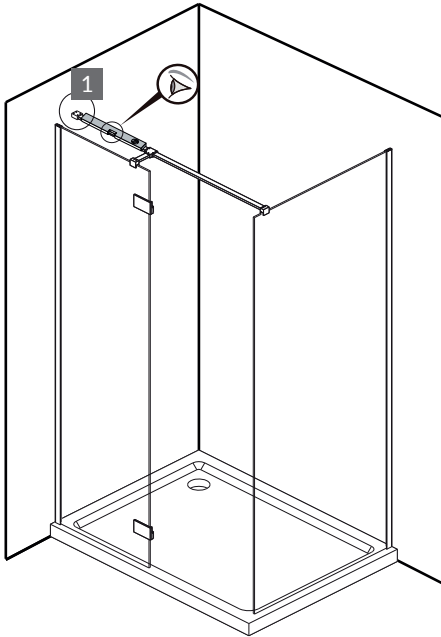
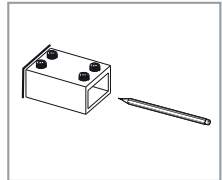
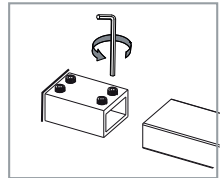
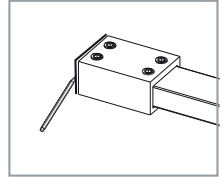
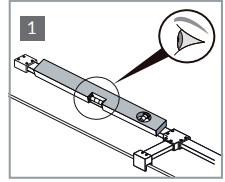
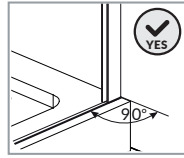
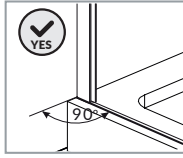
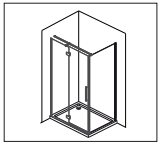

- P9 x1
- 4x35 x4    x4    3mm x1    2.5mm x1



10.

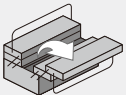
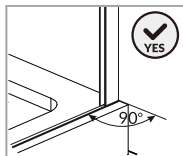
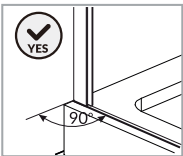
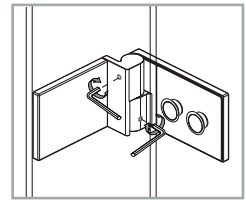
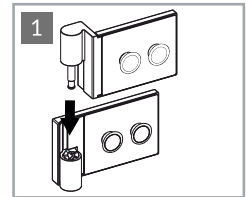
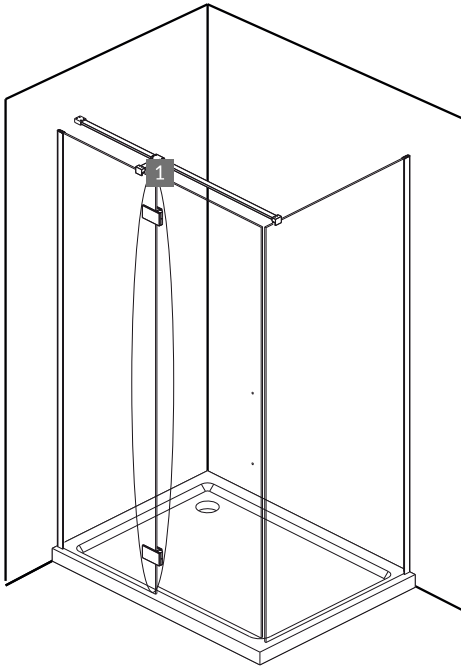
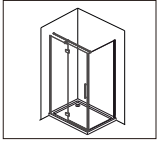



N  2mm x1

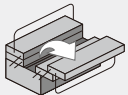
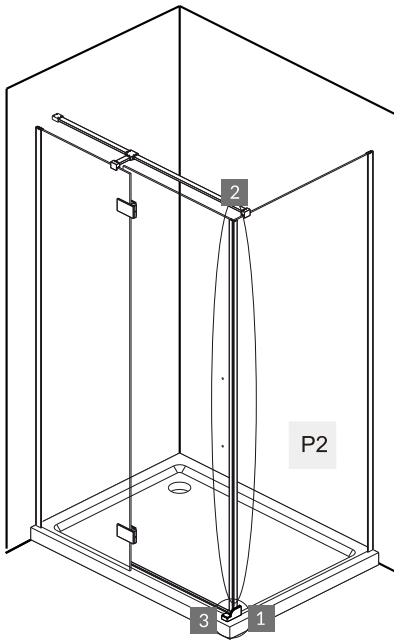
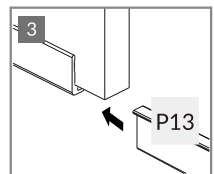
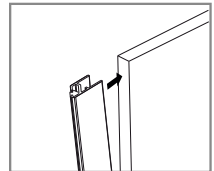
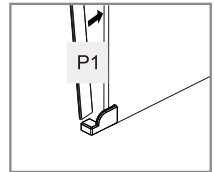
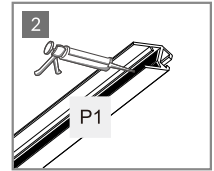
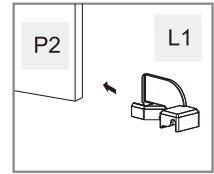
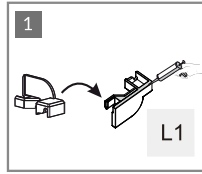
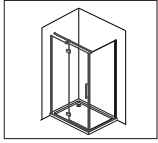

# 11.



- P1  x1
- P13  x1
- L1  x1



# 12.

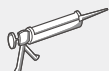
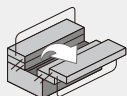
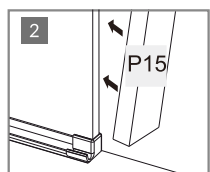
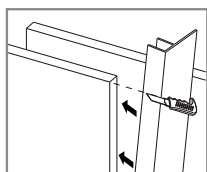
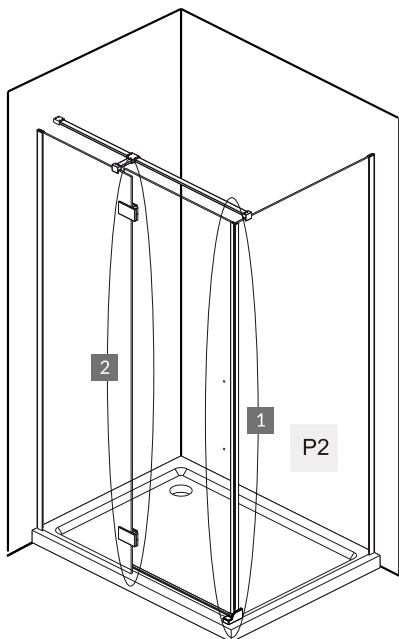
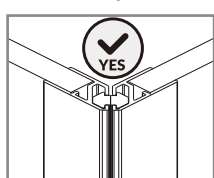
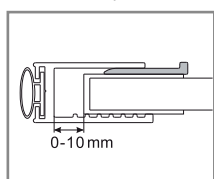
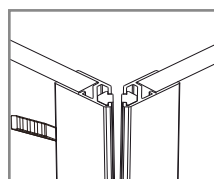
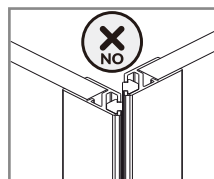
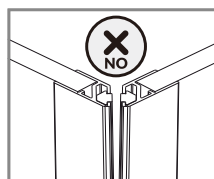
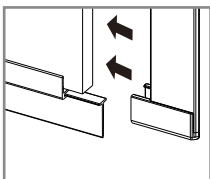
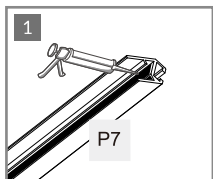
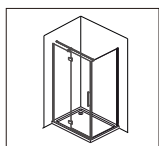

P7 ————— x1

P15 ————— x1

M ————— x1



13.

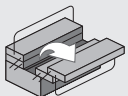
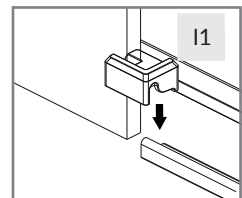
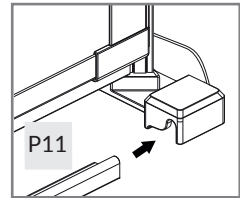
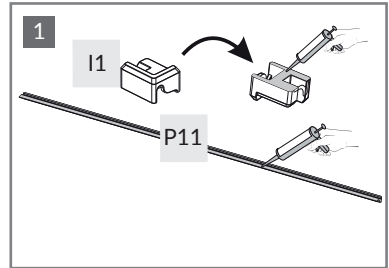
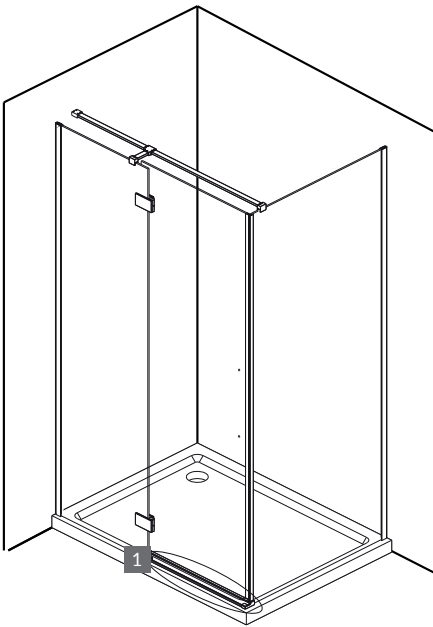
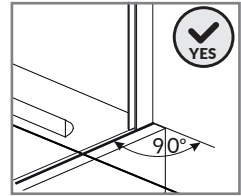
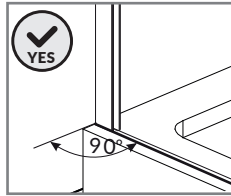
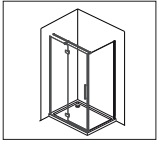

l1



x1

L1



x1

P11



x1





14.

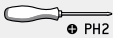
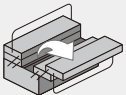
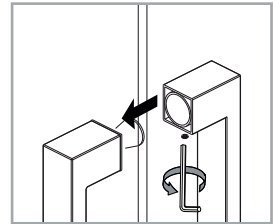
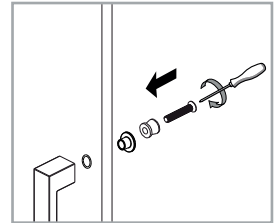
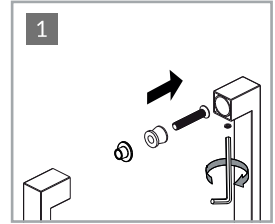
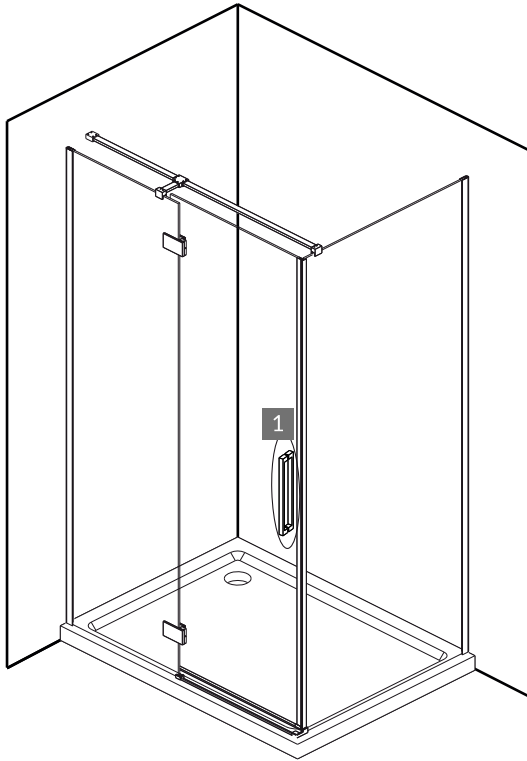
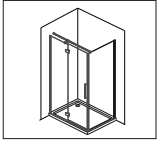

P14



x1



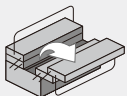
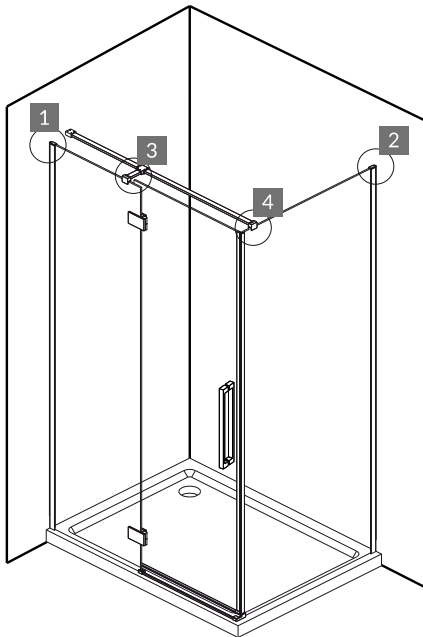
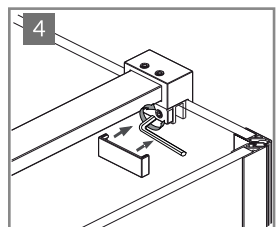
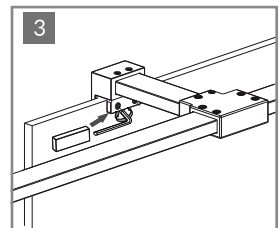
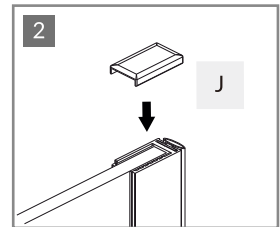
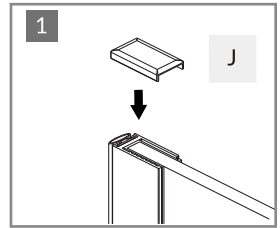
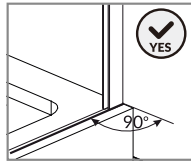
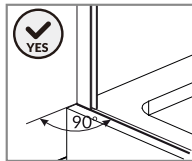
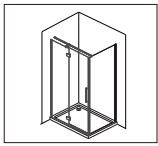

J



x2



16.

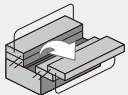
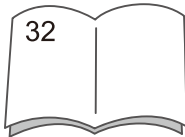
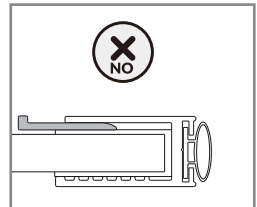
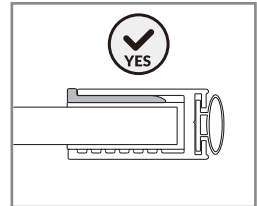
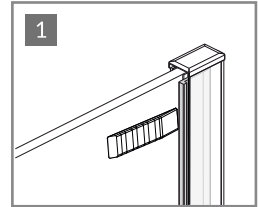
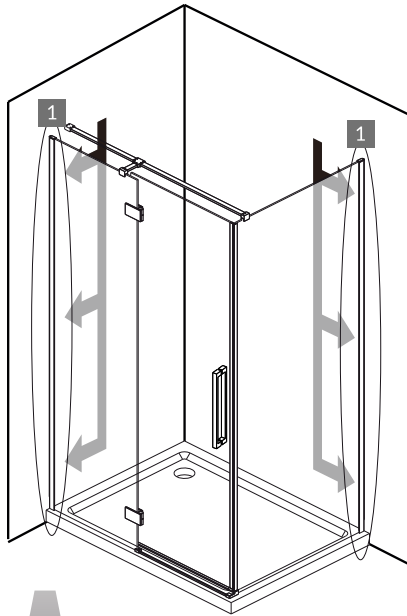
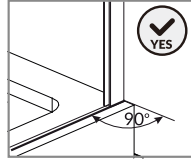
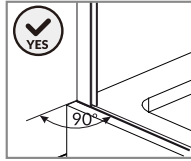
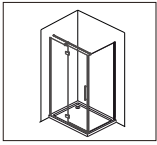

M



x1





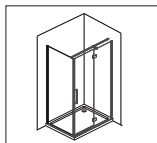

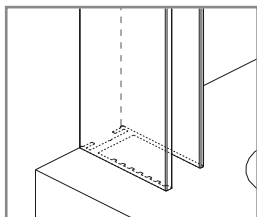
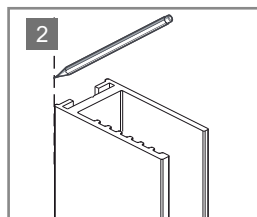
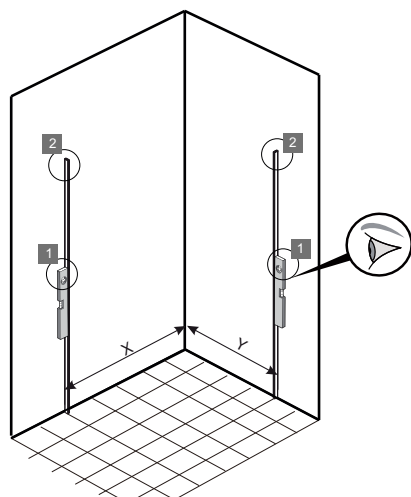
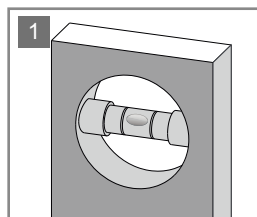
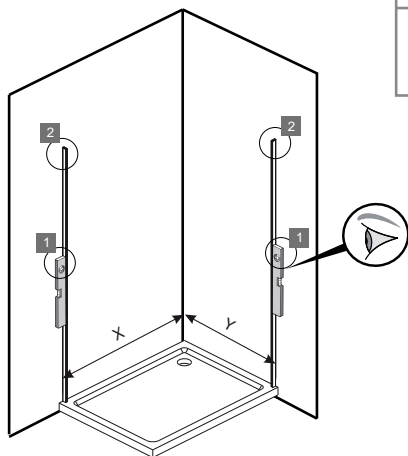

# 17.

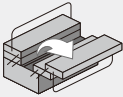

SIZE	X(mm)	Y(mm)
800X900X2000	893	793
800X1000X2000	993	793
800X1200X2000	1193	793
900X900X2000	893	893
900X1000X2000	993	893
900X1200X2000	1193	893





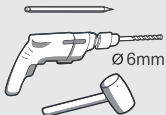
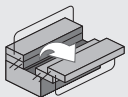
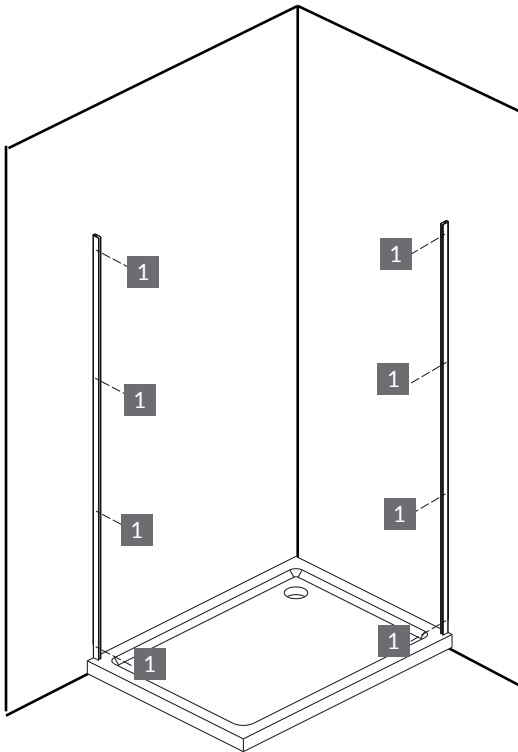
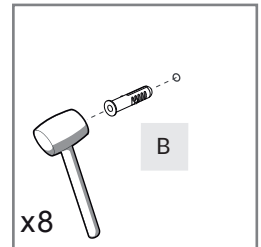
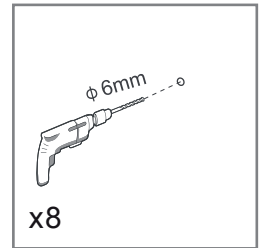
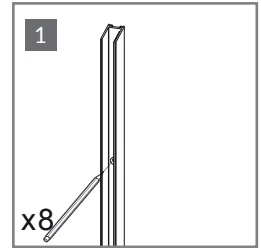
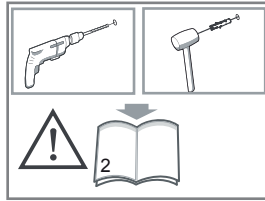
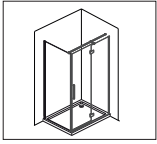

P5

2x

18.



B



x8



19.

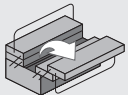
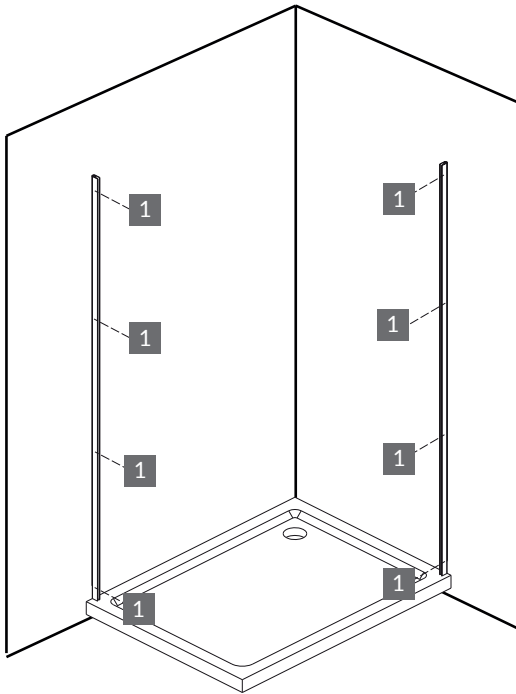
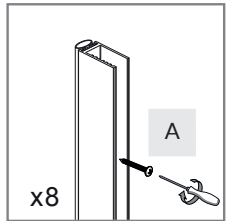
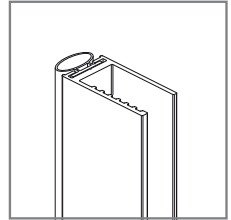
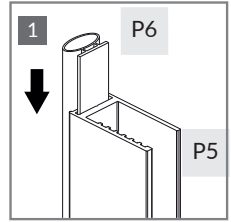
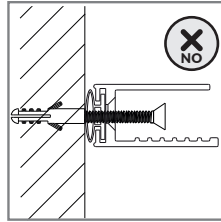
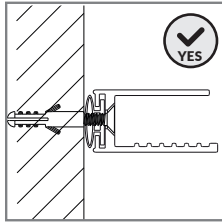
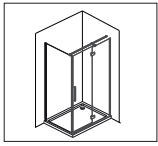

P6 ————— x2

P5 ————— x2

A  x8  
4X35



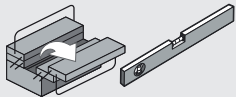
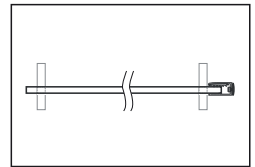
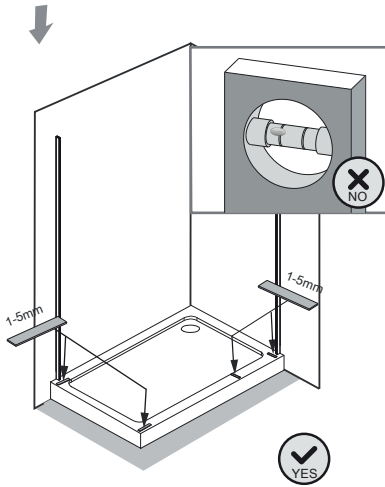
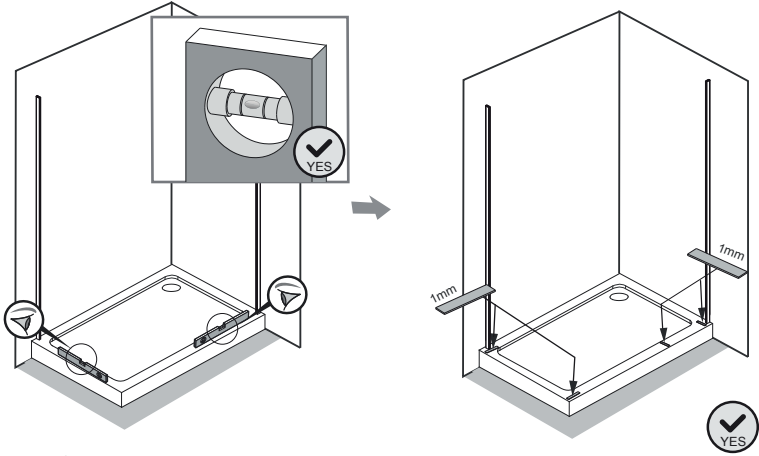
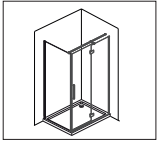

F1



x4

F2



x4

F3



x4



# 21.

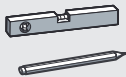
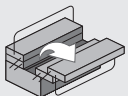
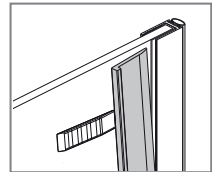
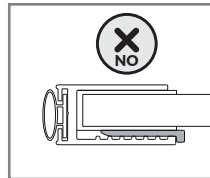
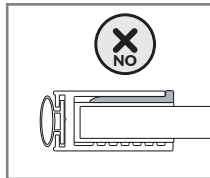
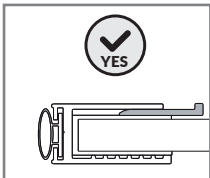
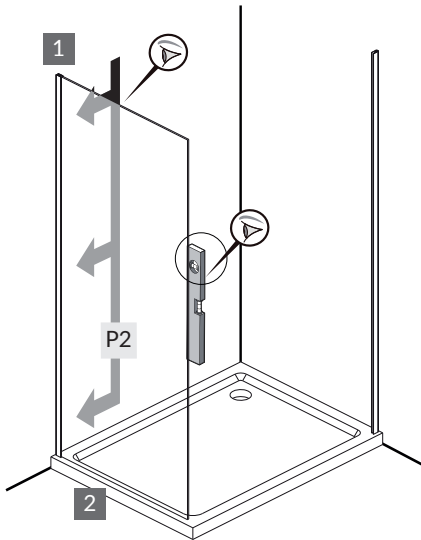
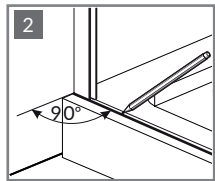
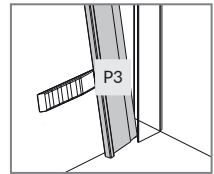
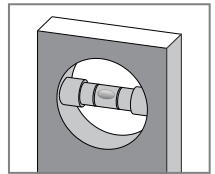
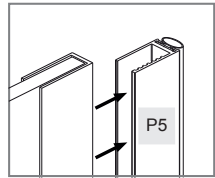
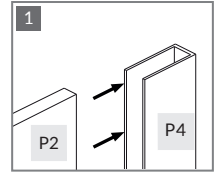
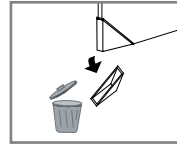
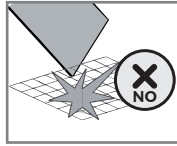
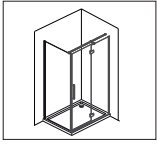

P4 ————— x1

P3 ————— x1

M ————— x1





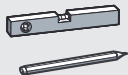
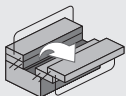
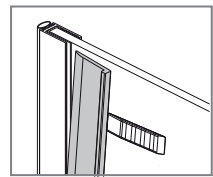
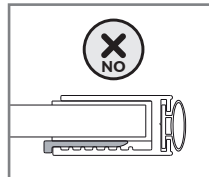
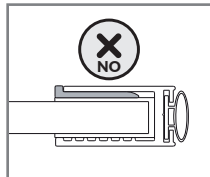
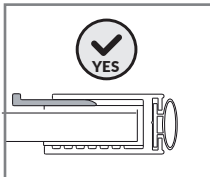
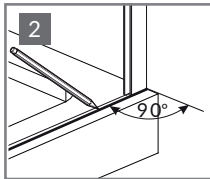
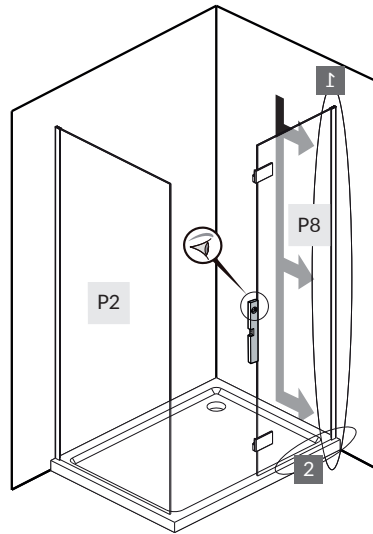
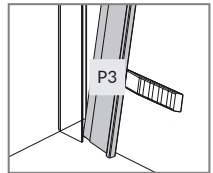
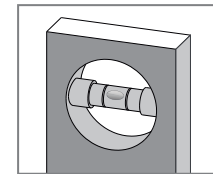
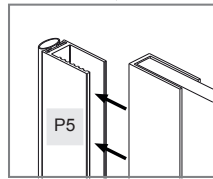
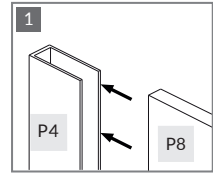
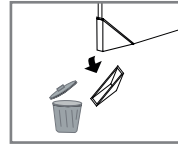
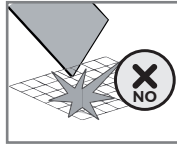
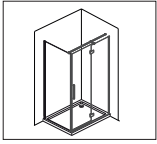

P4 ————— x1

P3 ————— x1

M ————— x1



23.

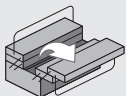
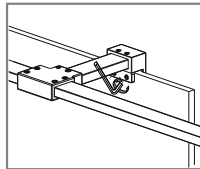
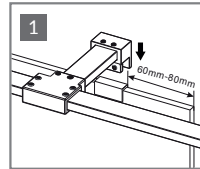
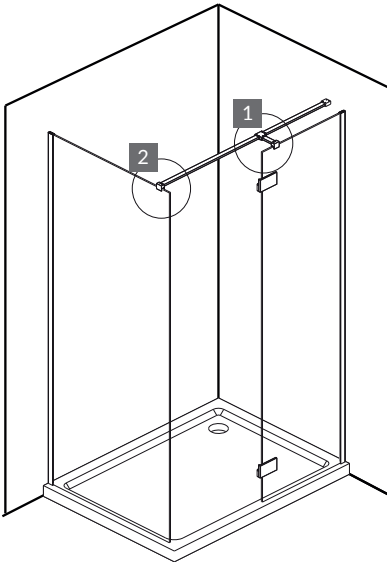
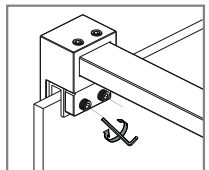
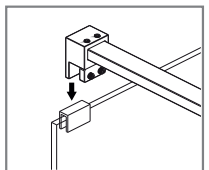
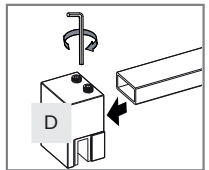
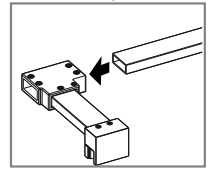
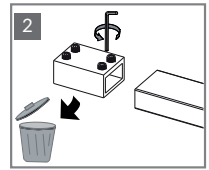
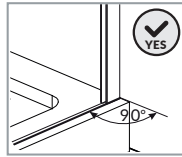
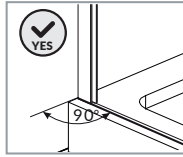
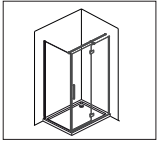

P9  x1

 x4

 x4

 x1

 x1

P10  x1

D  x1



# 24.

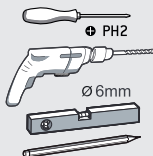
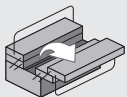
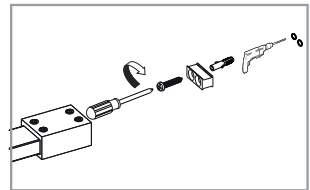
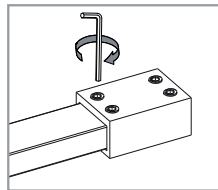
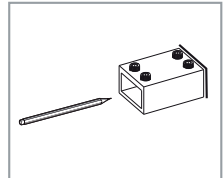
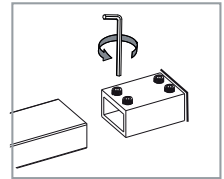
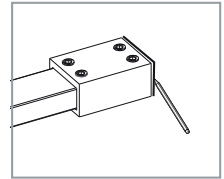
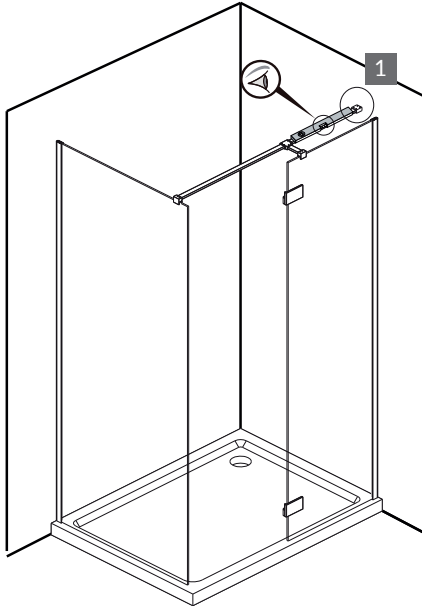
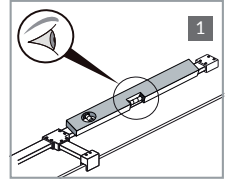
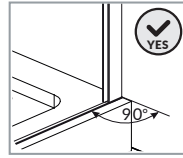
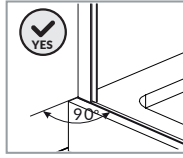
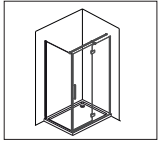

- P9 x1
- 4X35 x4
- x4
- 3mm x1
- 2.5mm x1



25.

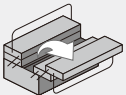
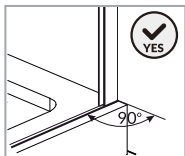
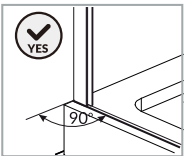
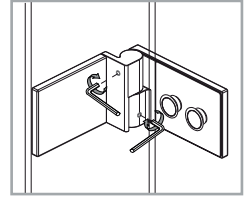
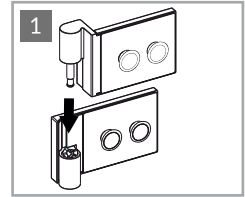
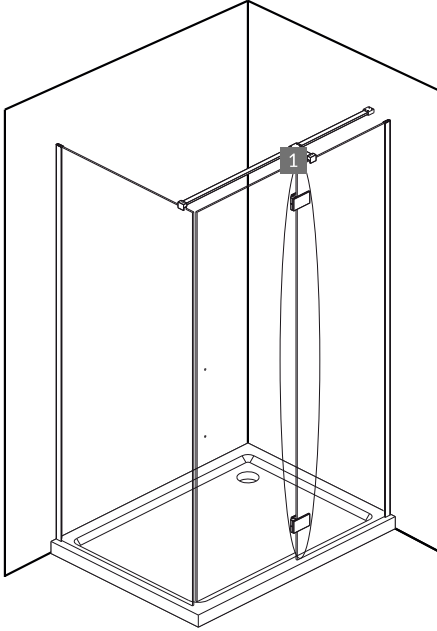
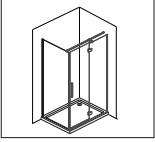

N



x1



26.

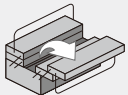
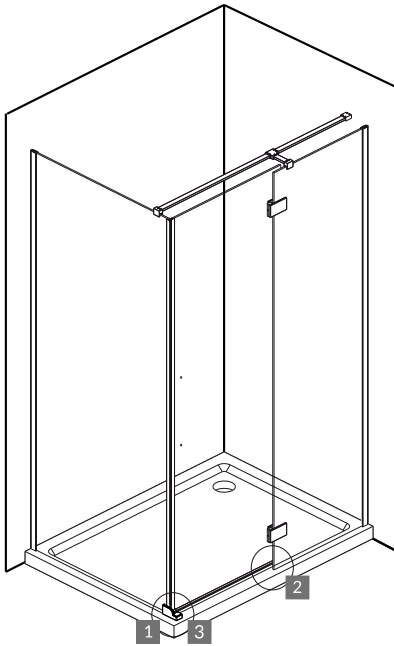
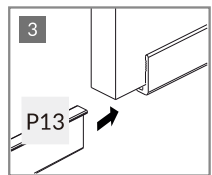
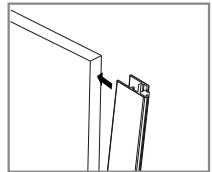
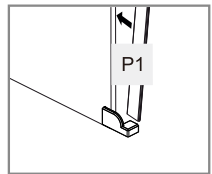
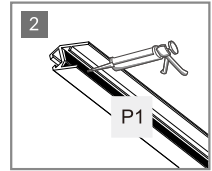
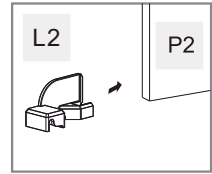
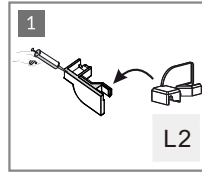
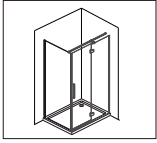

P1 ————— x1



P13 ————— x1

L2 ————— x1

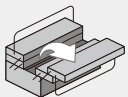
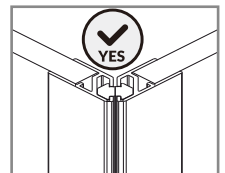
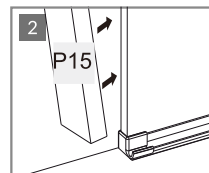
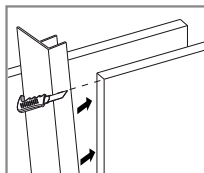
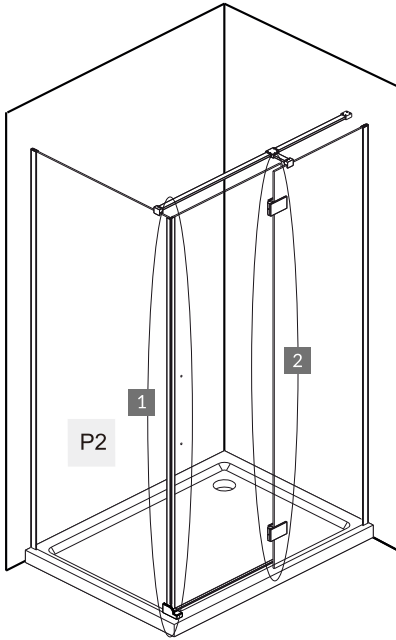
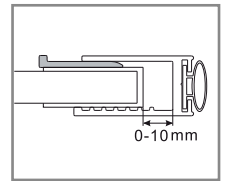
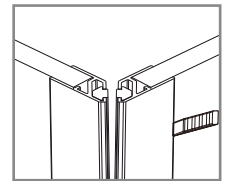
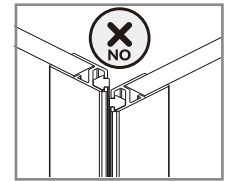
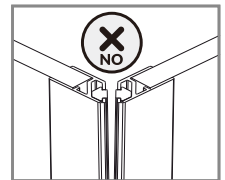
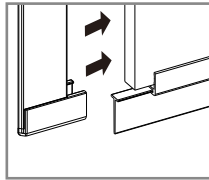
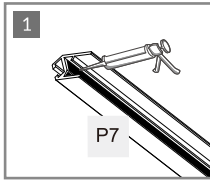
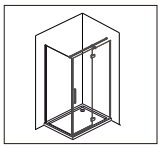

27.



- P7  x1
- P15  x1
- M  x1



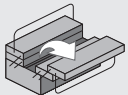
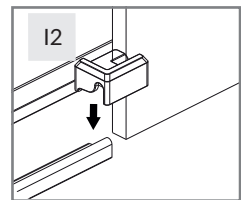
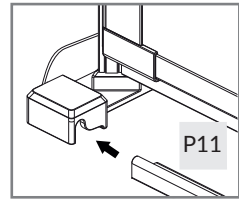
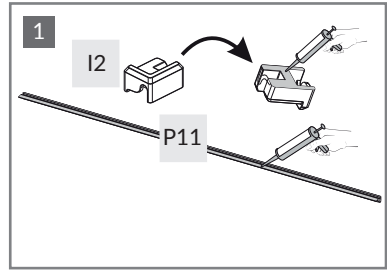
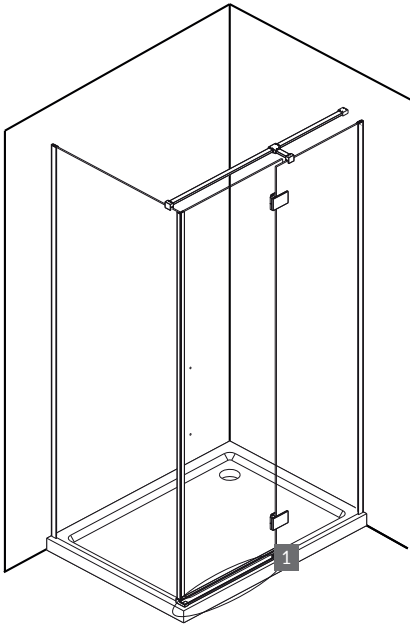
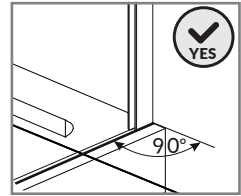
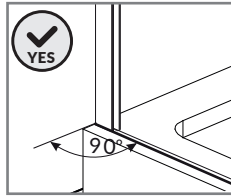
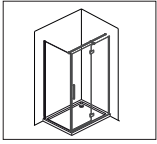

I2



x1

L2



x1

P11



x1



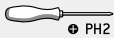
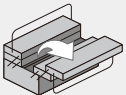
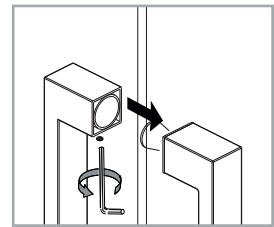
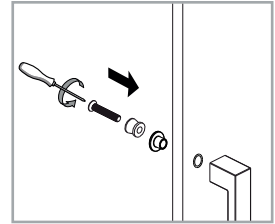
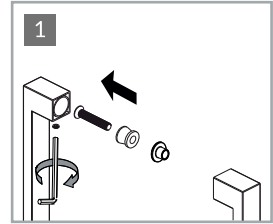
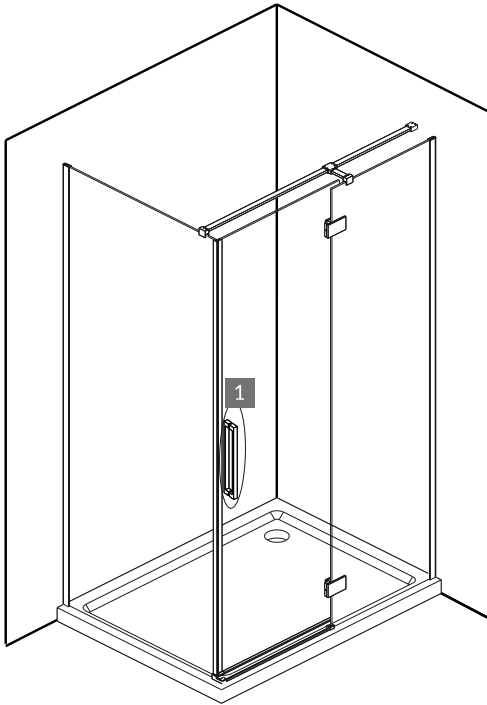
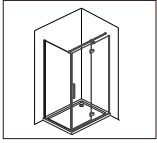

P14



x1





30.

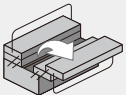
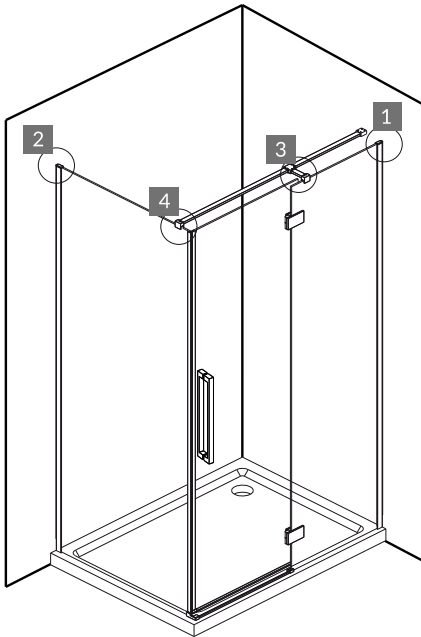
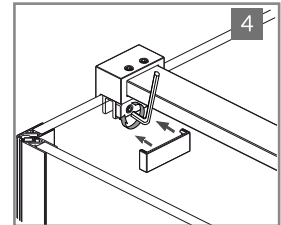
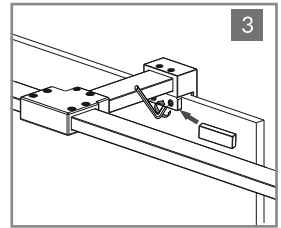
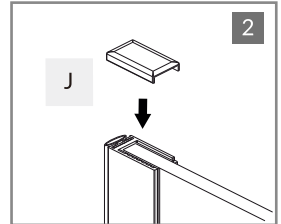
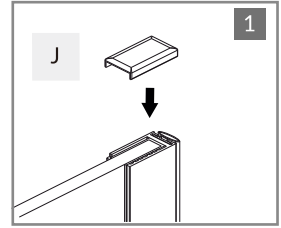
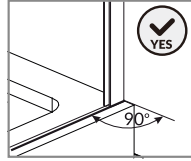
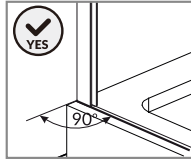
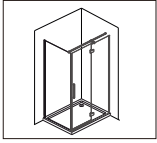

J



x2



31.

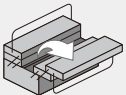
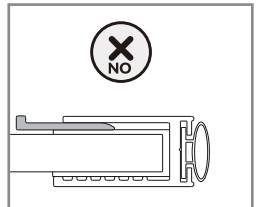
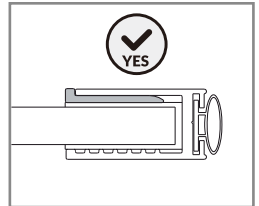
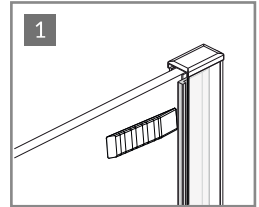
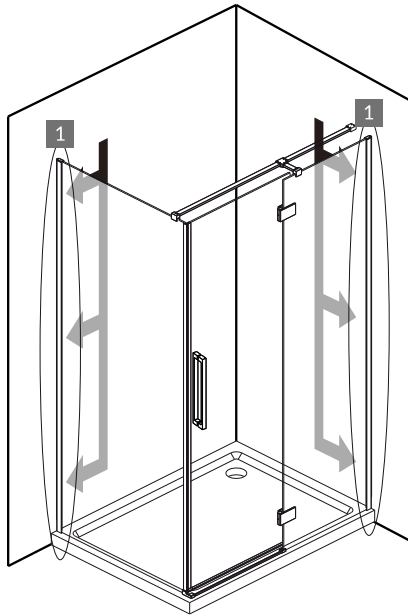
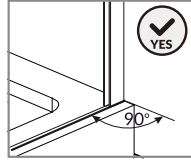
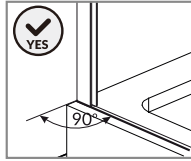
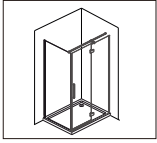

M



x1



32.

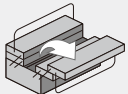
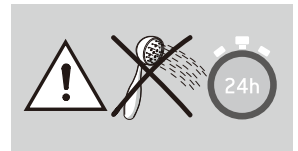
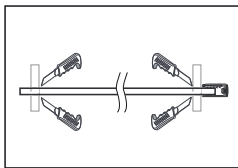
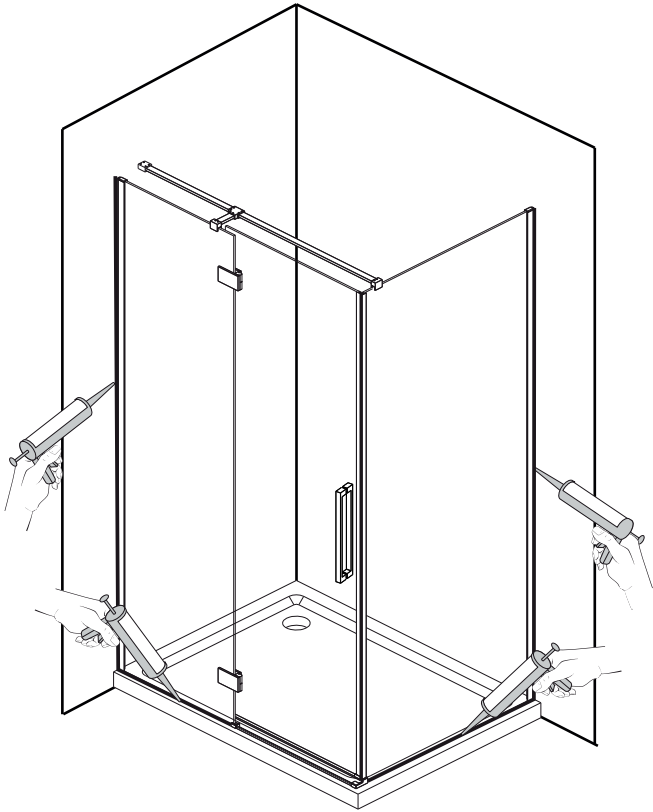
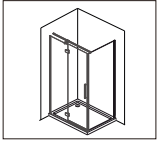



6.5 < PH < 7.5

