

Moduo

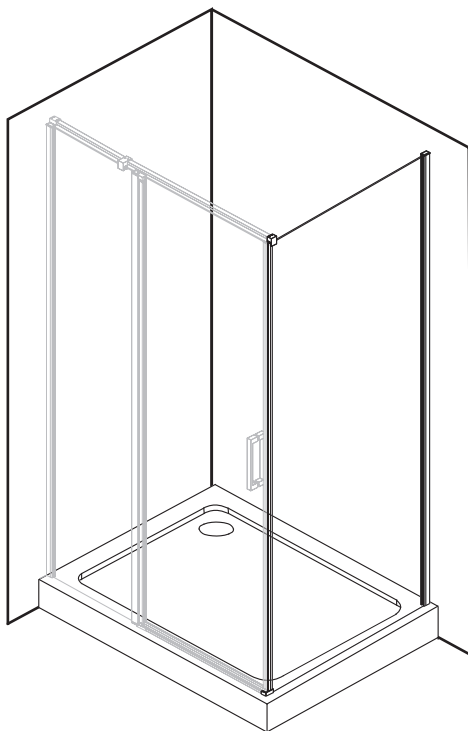

PL INSTRUKCJA MONTAŻU I EKSPLOATACJI

CZ NÁVOD NA MONTÁŽ A ÚDRŽBU

SK NÁVOD NA MONTÁŽ A ÚDRŽBU

EST PAIGALDUS- JA KASUTUSJUHEND

LT MONTAVIMO IR EKSPLOATAVIMO INSTRUKCIJA

LV MONTĀŽAS UN EKSPLUATĀCIJAS INSTRUKCIJA

DE MONTAGE- UND AUFBAUANLEITUNG

RO INSTRUCȚIUNI DE MONTAJ ȘI OPERARE

HU SZERELÉSI ÉS ÜZEMELTETÉSI ÚTMUTATÓ

UA ІНСТРУКЦІЯ З МОНТАЖУ І ЕКСПЛУАТАЦІЇ

BY ІНСТРУКЦЫЯ ПА МАНТАЖЫ І ЭКСПЛУАТАЦЫІ

RU ИНСТРУКЦИЯ ПО МОНТАЖУ И ЭКСПЛУАТАЦИИ

EN INSTRUCTIONS FOR ASSEMBLY AND USE

FR INSTALLATION ET UTILISATION - MODE

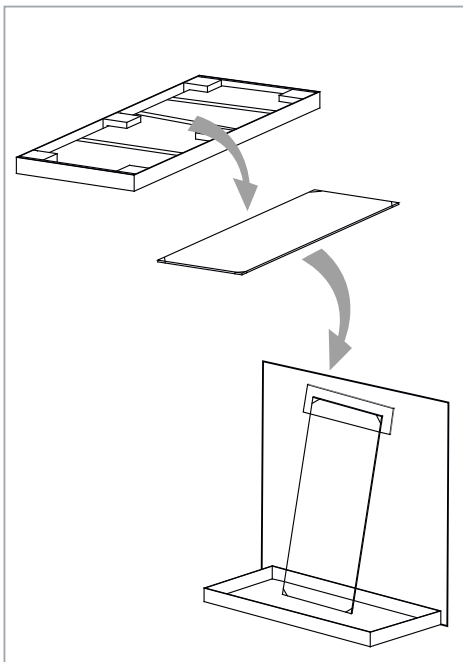
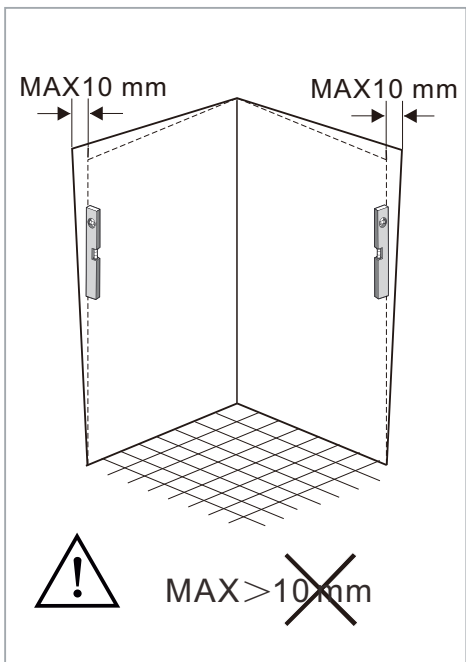
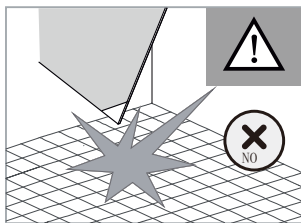
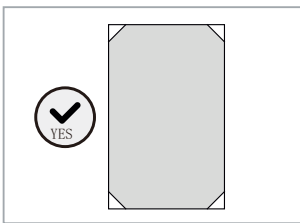
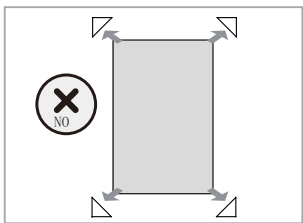
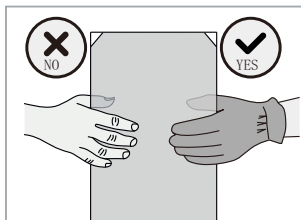
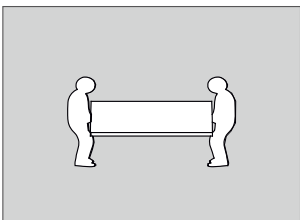
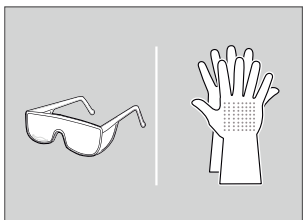
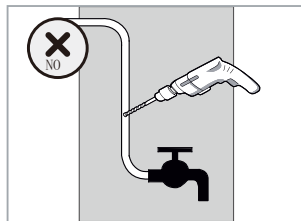
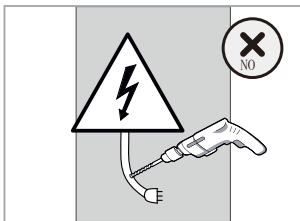
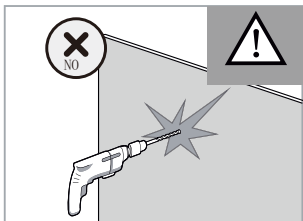

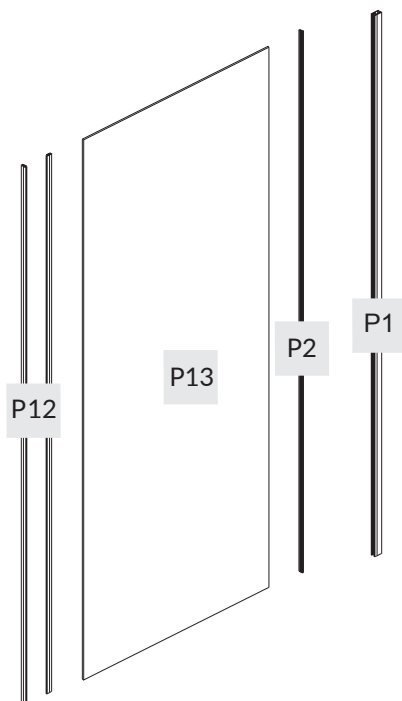

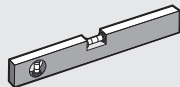
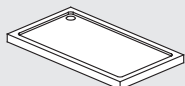
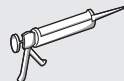
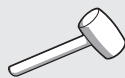
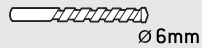
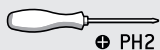
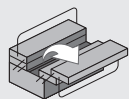
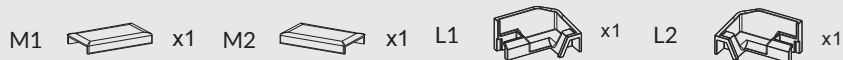
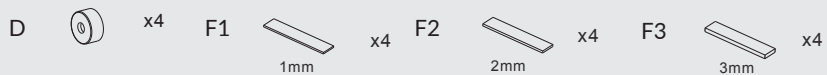

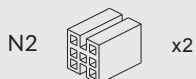
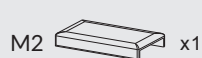
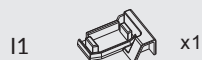
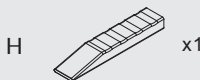
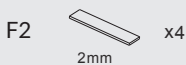
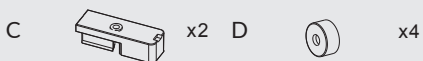
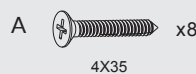
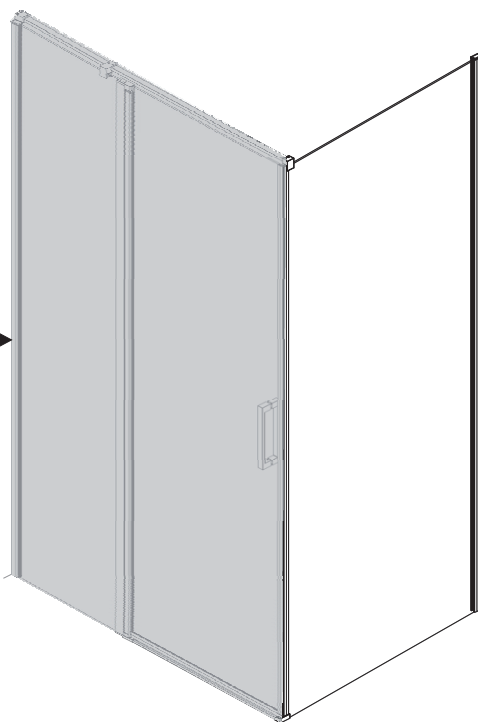
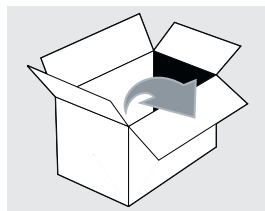

1.

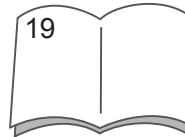
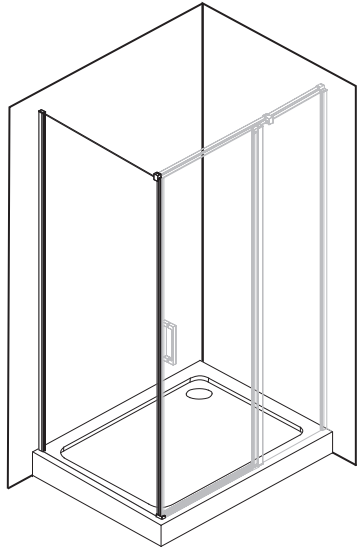
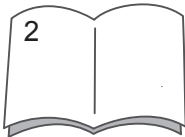
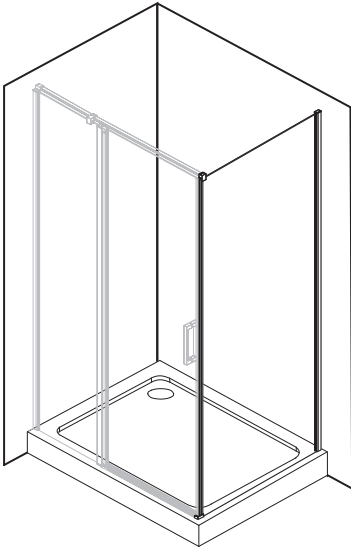

2.

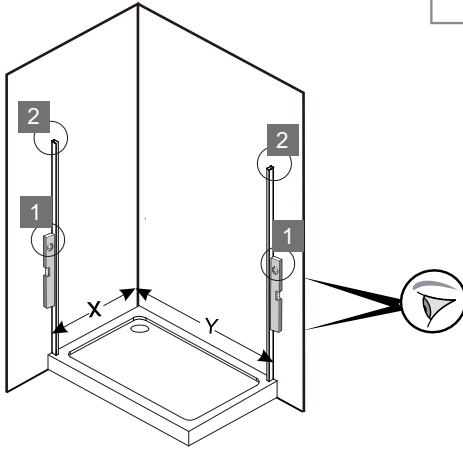
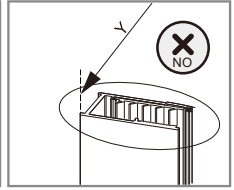
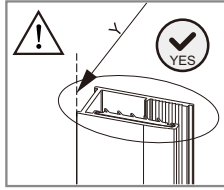
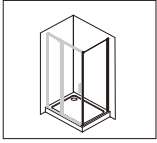

SIZE	X(mm)	Y(mm)
800x800x1950	783	795
800x900x1950	783	895
800x1000x1950	783	995
900x800x1950	883	795
900x900x1950	883	895
900x1000x1950	883	995

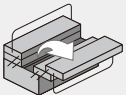
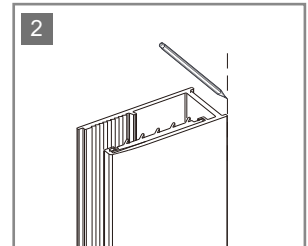
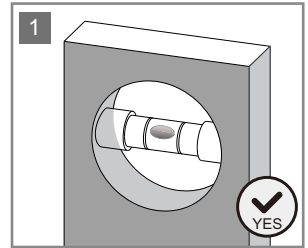
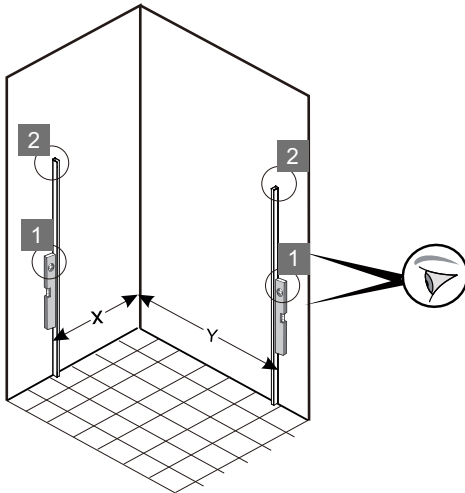

P1



x2



3.

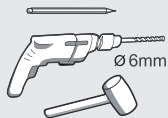
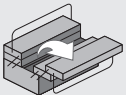
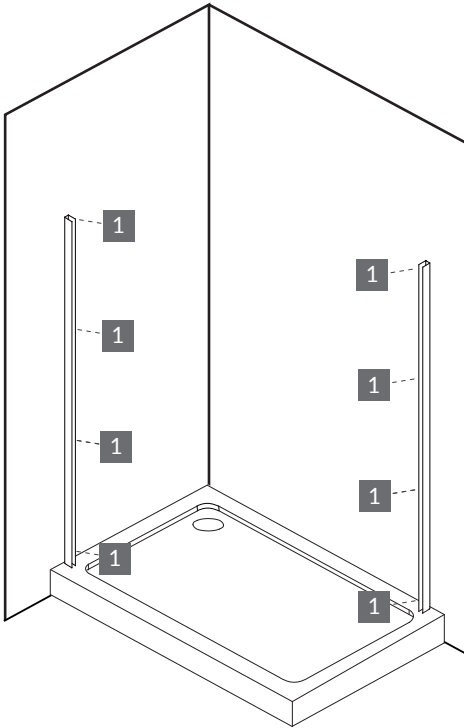
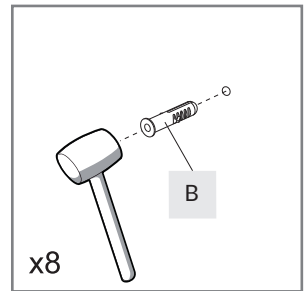
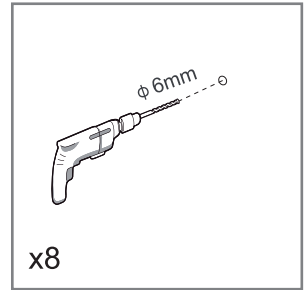
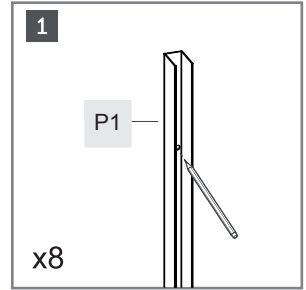
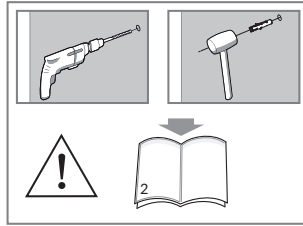
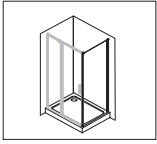

B



x8



4.

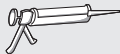
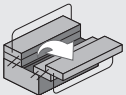
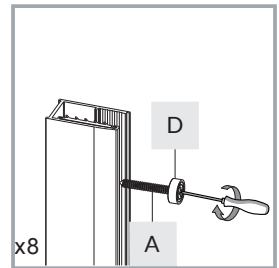
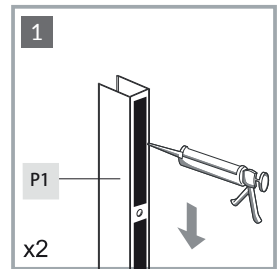
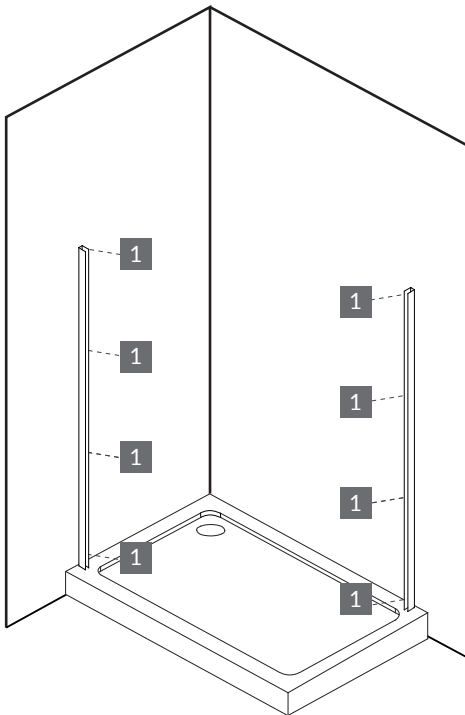
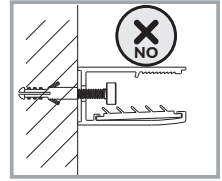
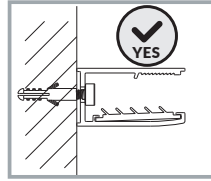
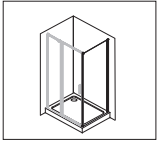

P1



x2

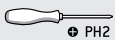

PH2

D



x8

A



4X35

x8



5.

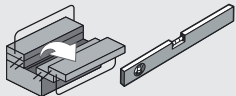
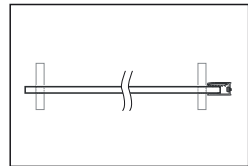
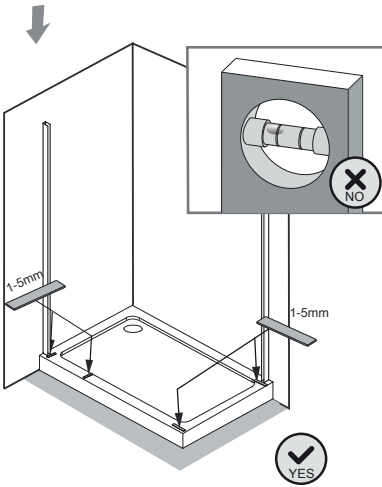
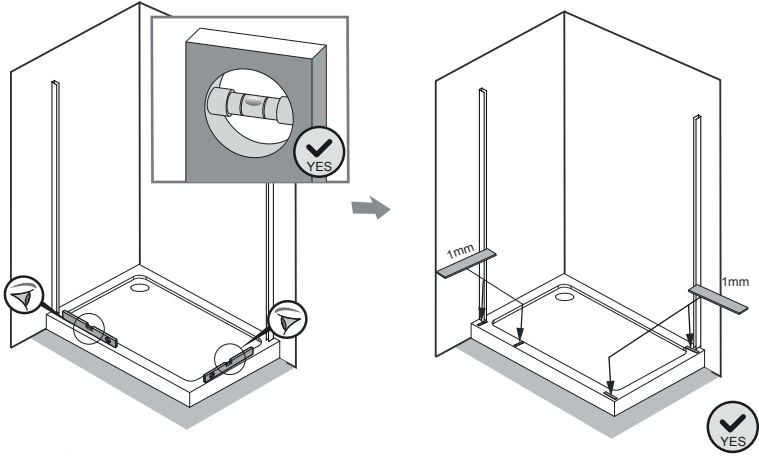
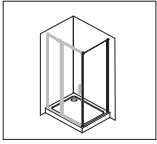

F1



x4

F2



x4

F3



x4



6.

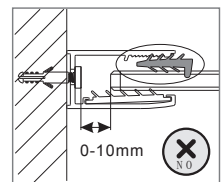
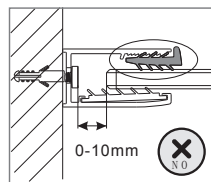
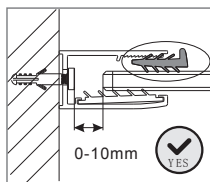
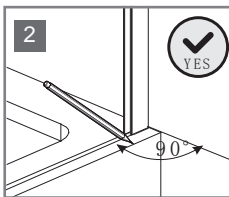
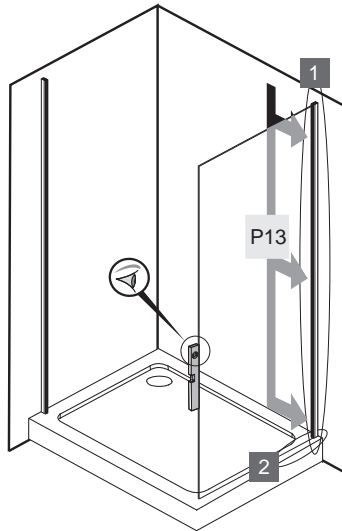
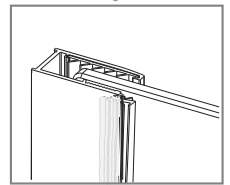
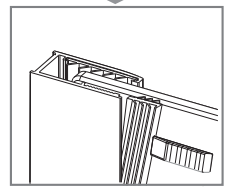
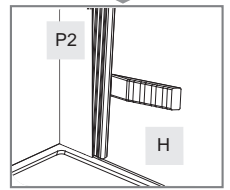
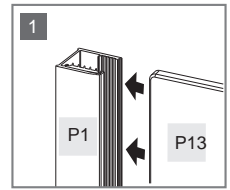
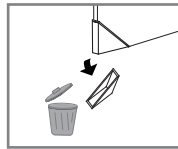
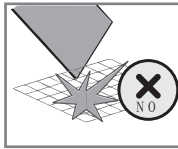
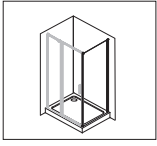

7.

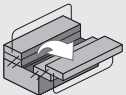
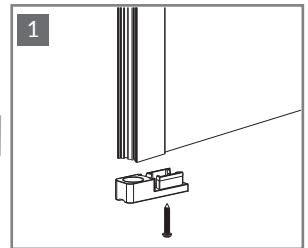
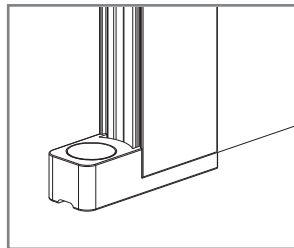
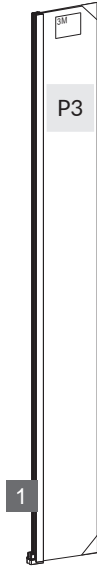
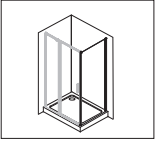

PH2

C

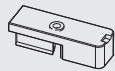

x1

E



x1



8.

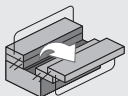
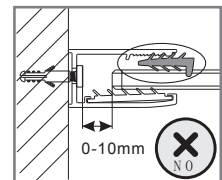
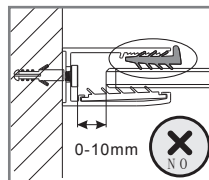
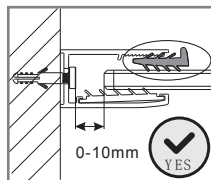
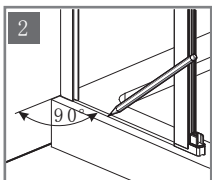
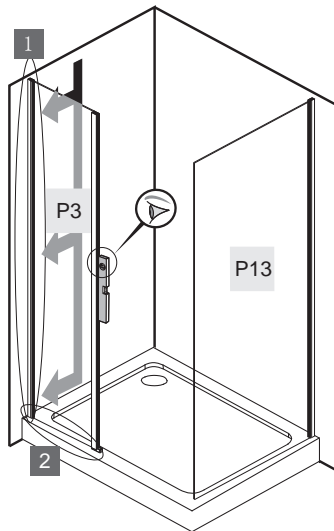
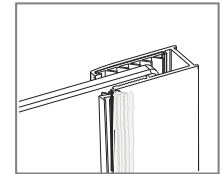
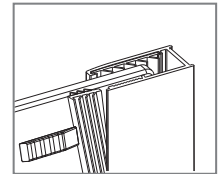
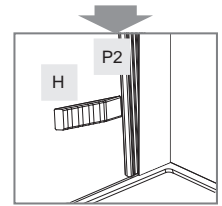
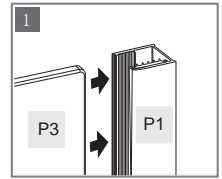
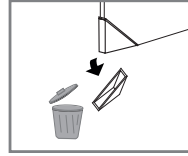
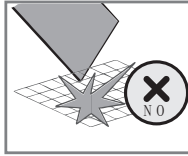
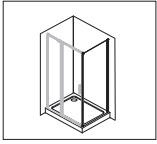

P2 ————— x1

H ————— x1



9.

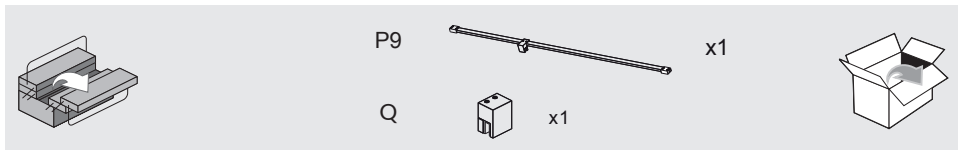
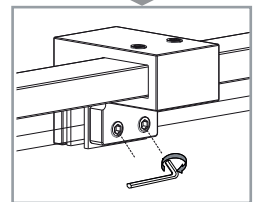
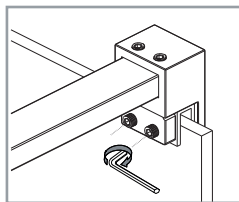
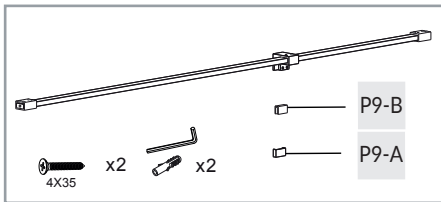
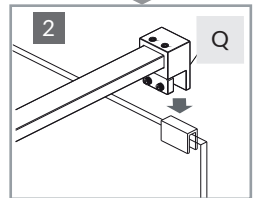
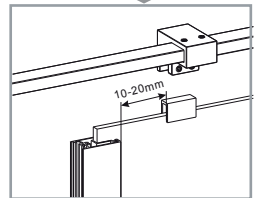
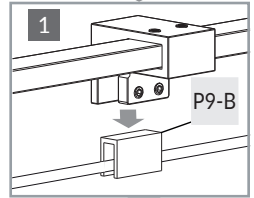
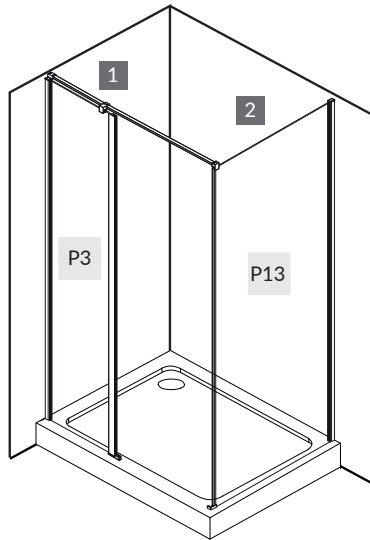
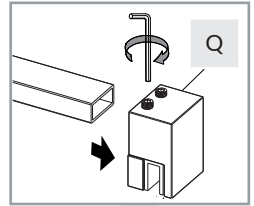
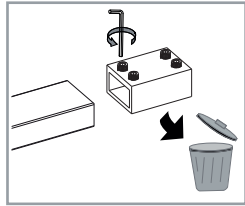
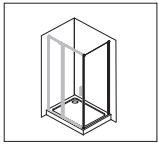

10.

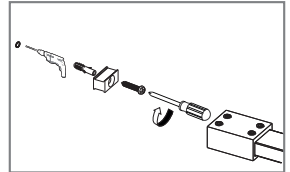
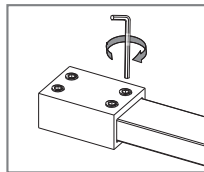
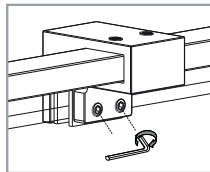
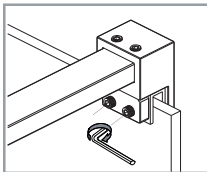
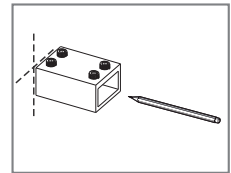
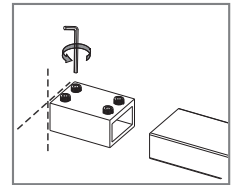
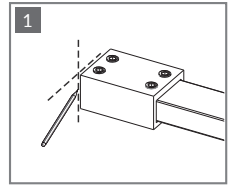
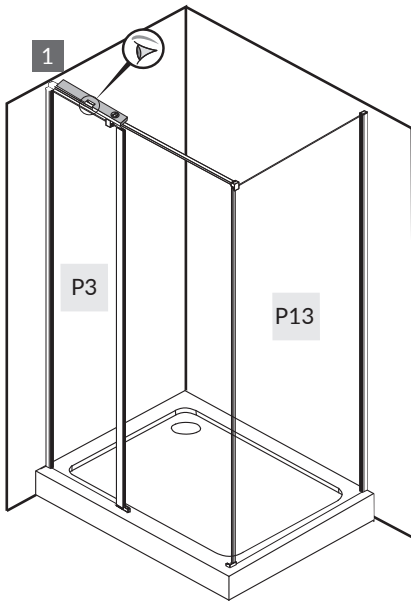
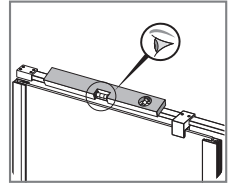
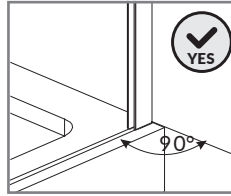
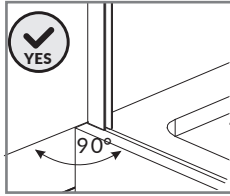
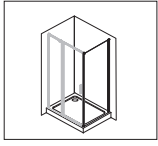

11.

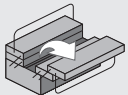
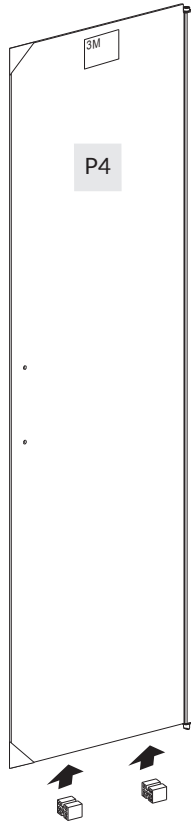
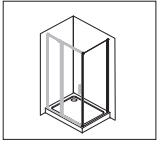

N2



x2



12.

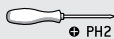
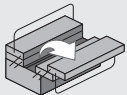
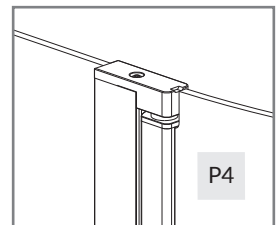
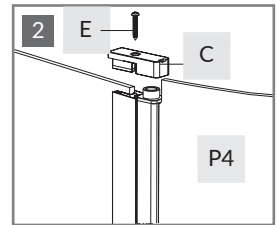
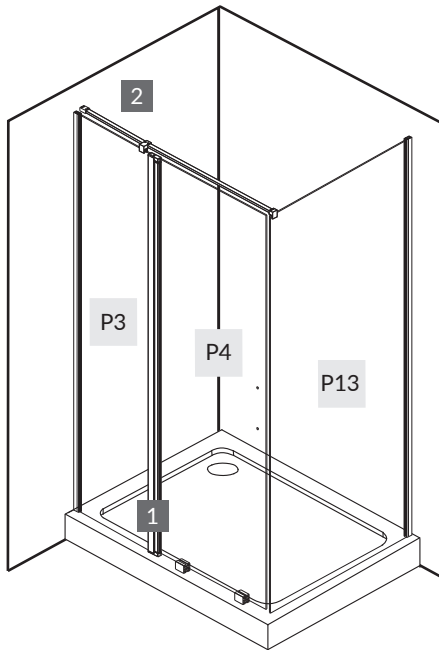
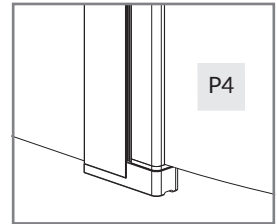
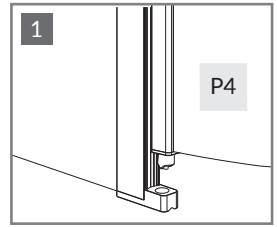
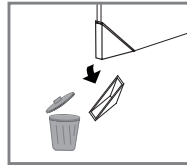
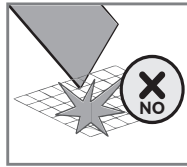
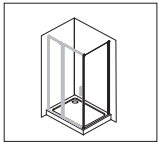

C

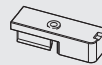

x1

E



x1



13.

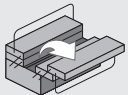
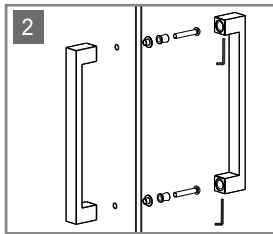
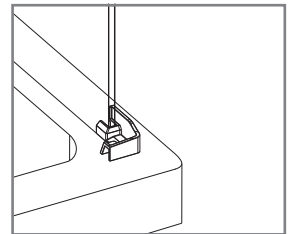
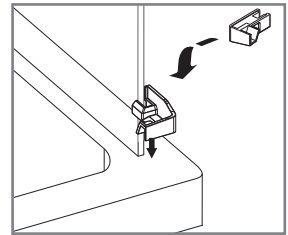
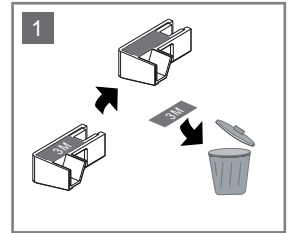
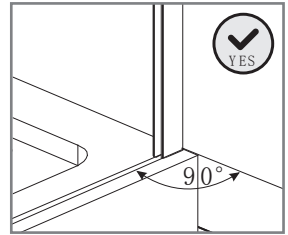
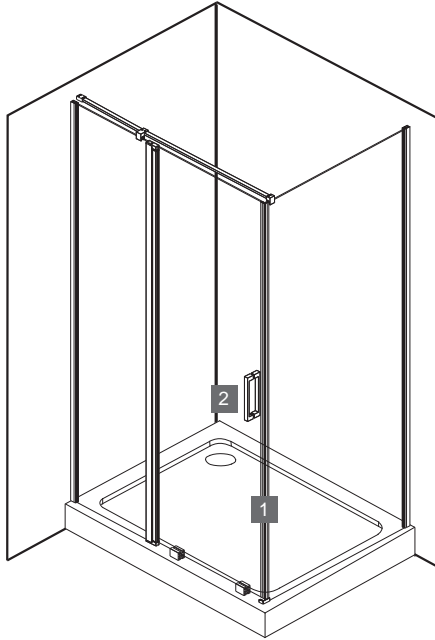
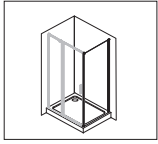

P5



x1



L1



x1



14.

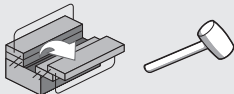
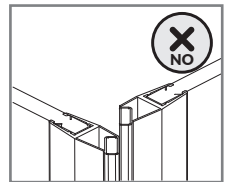
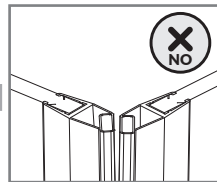
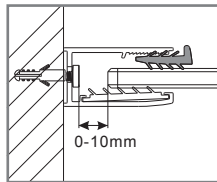
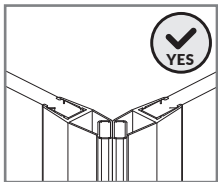
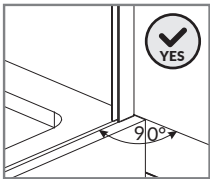
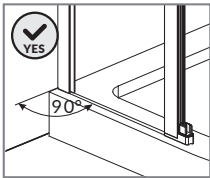
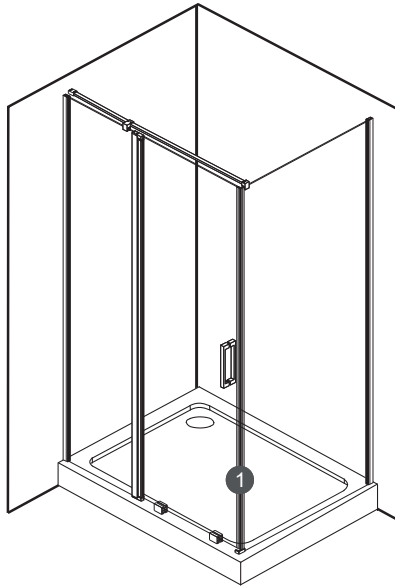
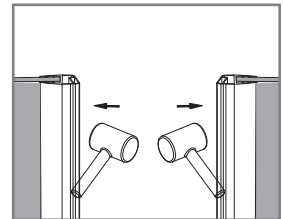
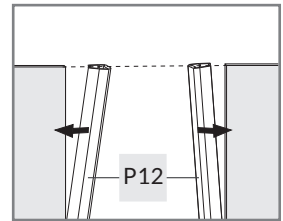
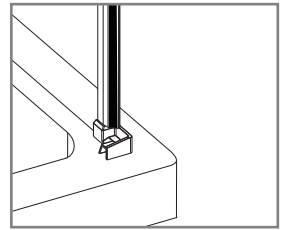
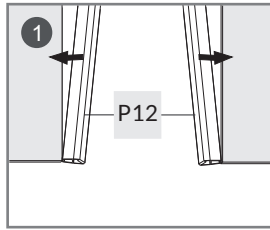
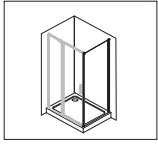

P12



x2



15.

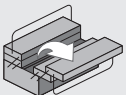
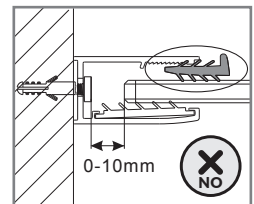
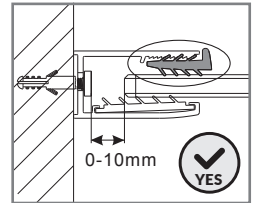
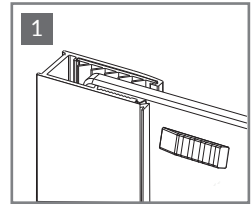
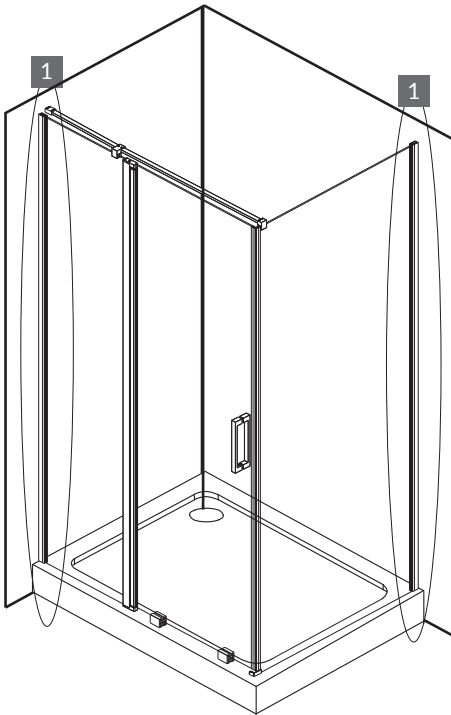
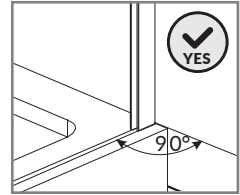
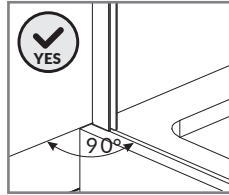
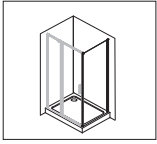

H



x1



16.

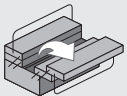
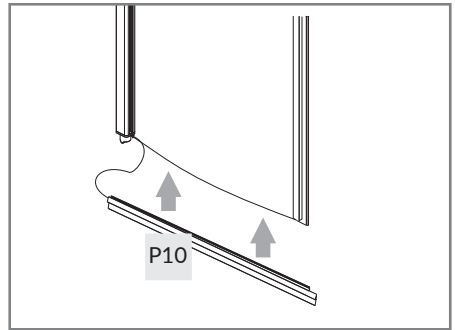
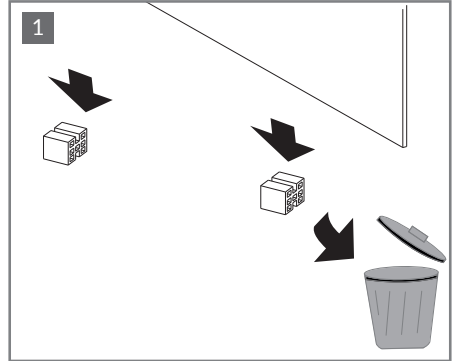
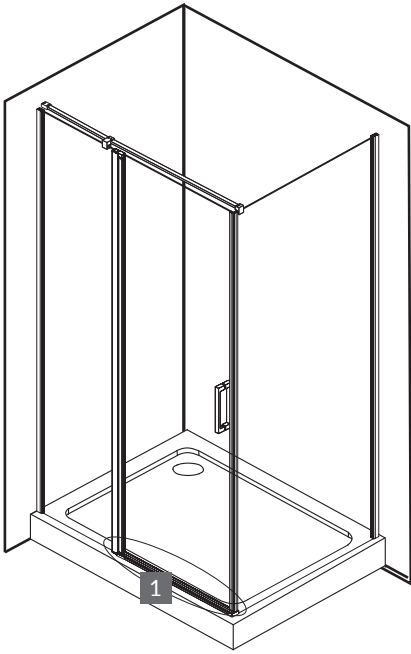
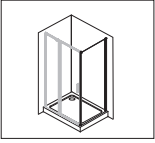

P10



x1



17.

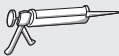
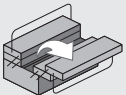
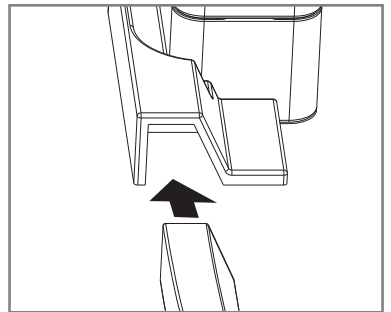
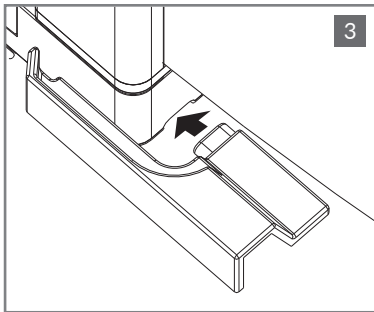
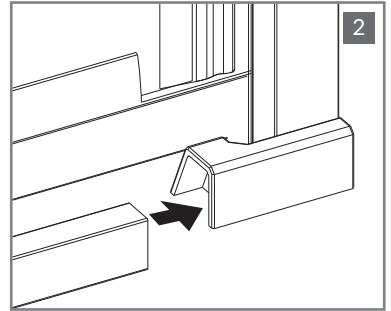
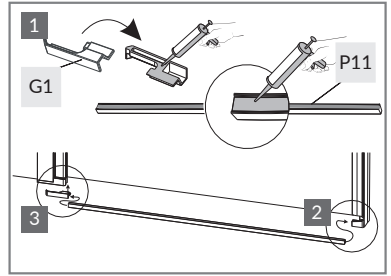
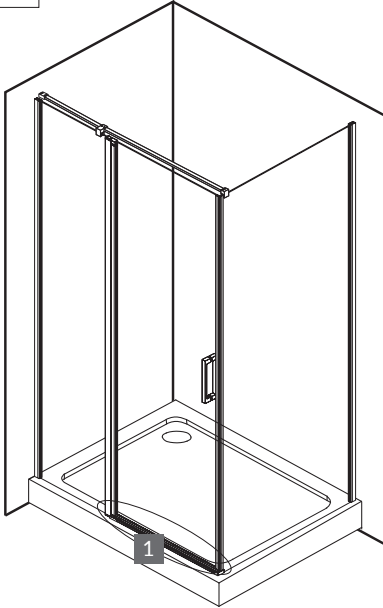
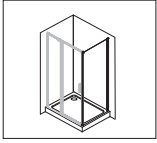

P11



x1

G1



x1



18.

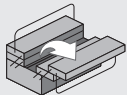
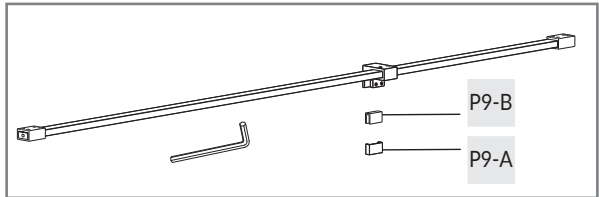
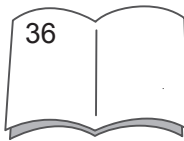
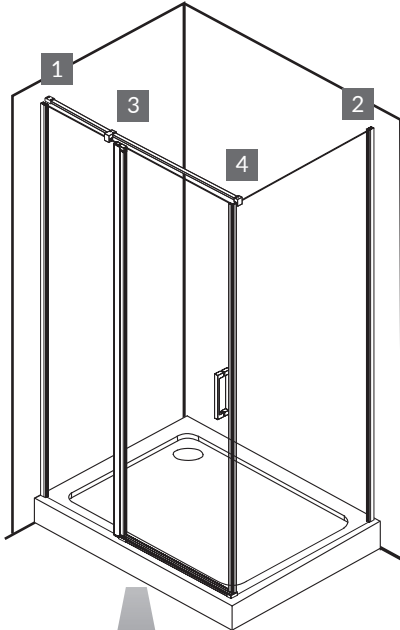
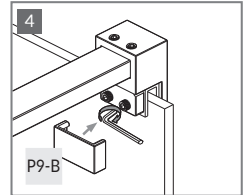
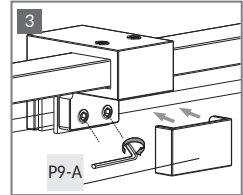
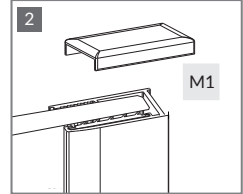
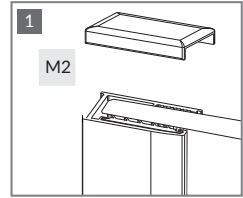
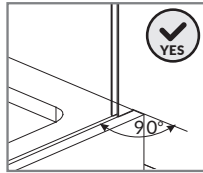
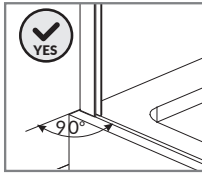
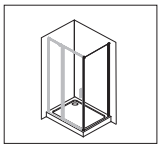

M2  x1

M1  x1



19.

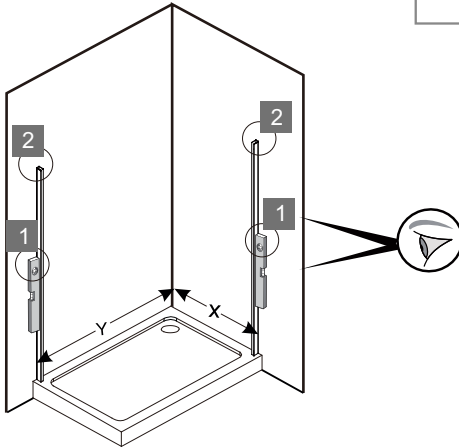
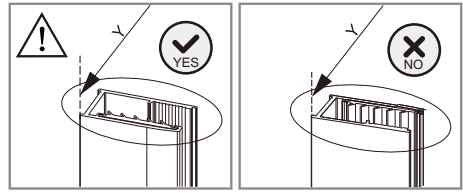
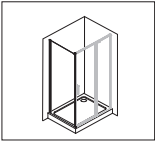

SIZE	X(mm)	Y(mm)
800x800x1950	783	795
800x900x1950	783	895
800x1000x1950	783	995
900x800x1950	883	795
900x900x1950	883	895
900x1000x1950	883	995

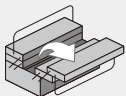
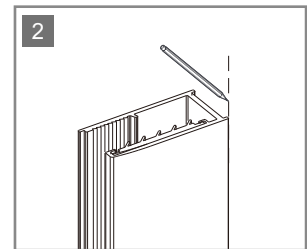
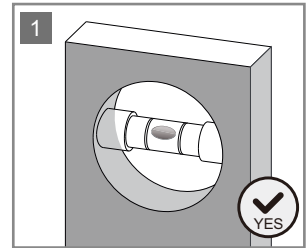
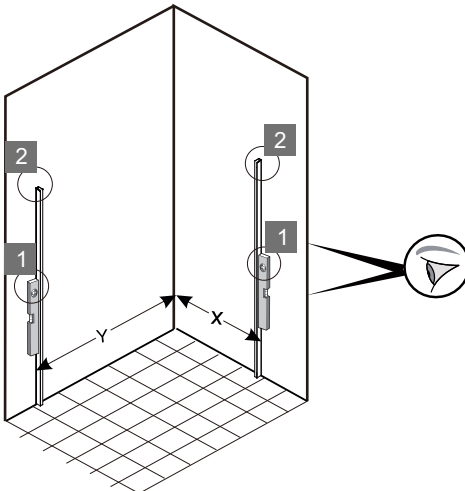

P1



x2



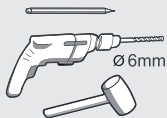
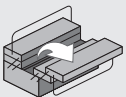
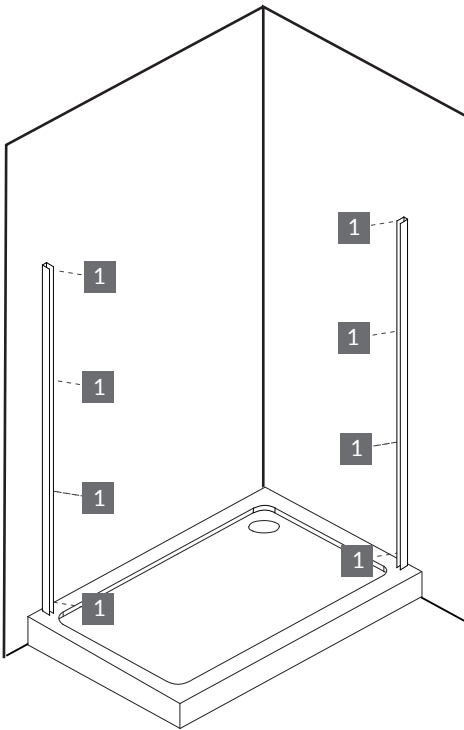
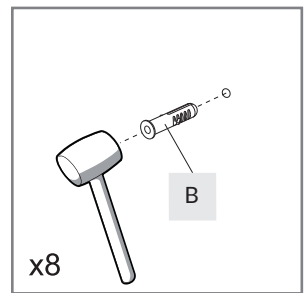
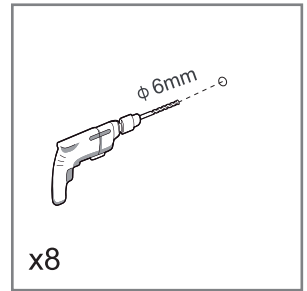
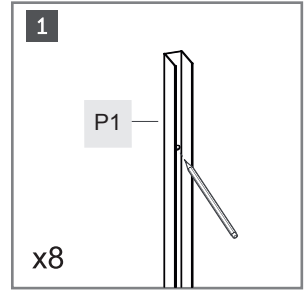
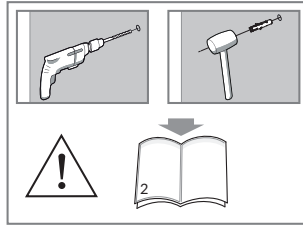
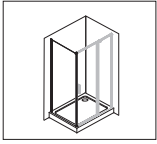

B



x8



21.

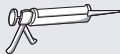
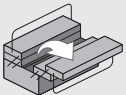
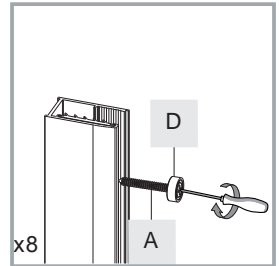
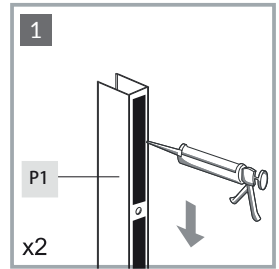
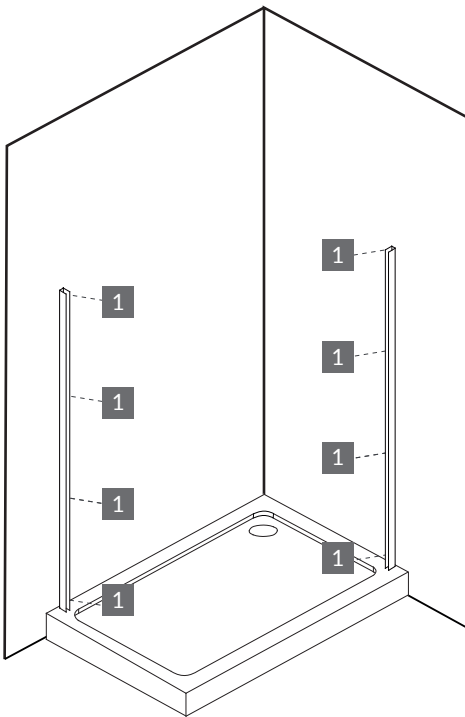
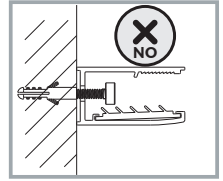
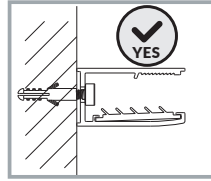
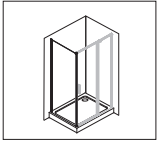

P1



x2

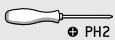

PH2

D



x8

A



4X35

x8



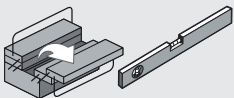
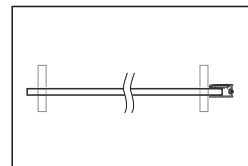
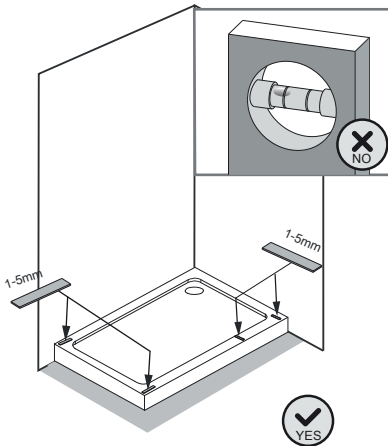
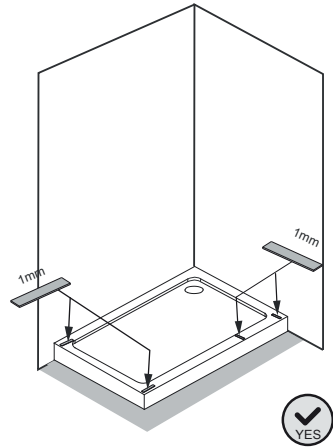
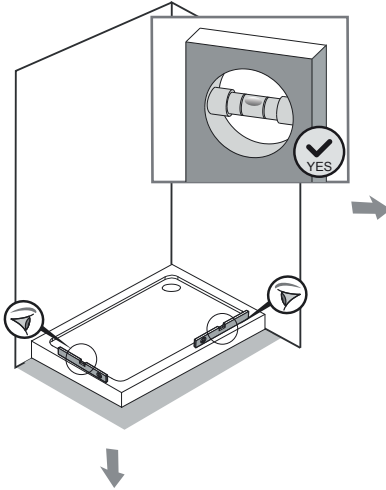
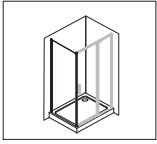

F1

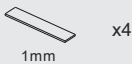

F2

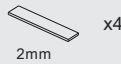

F3



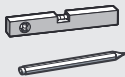
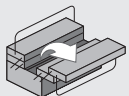
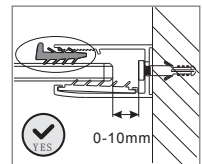
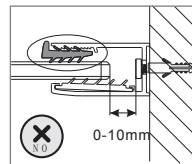
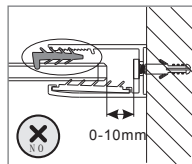
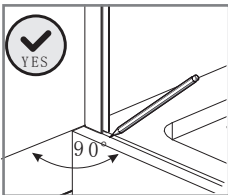
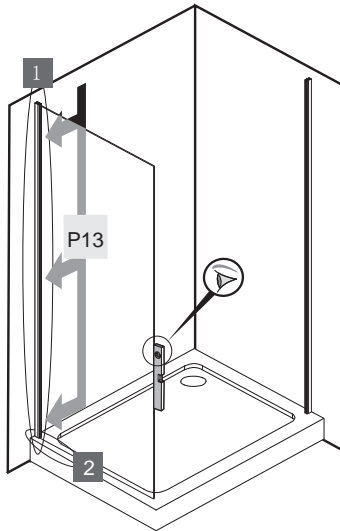
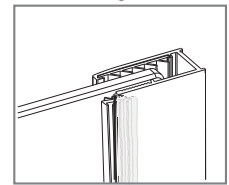
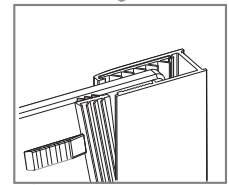
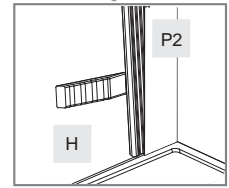
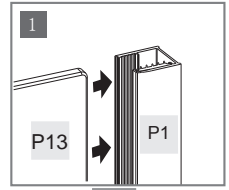
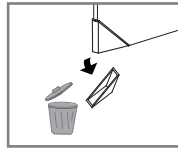
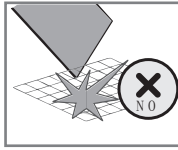
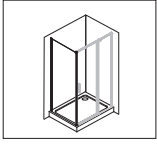

P2



x1

H



x1



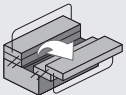
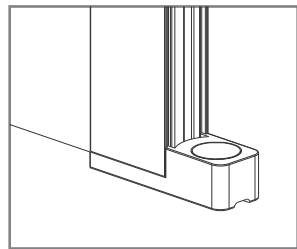
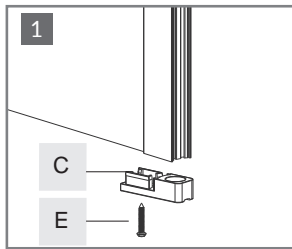
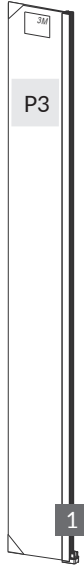
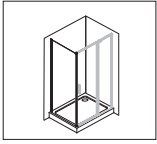

C

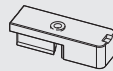

x1

E



x1



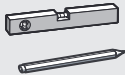
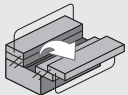
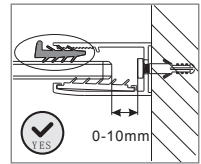
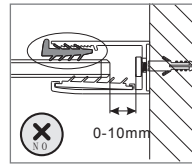
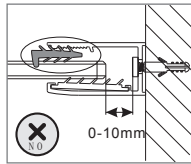
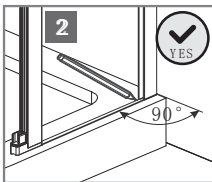
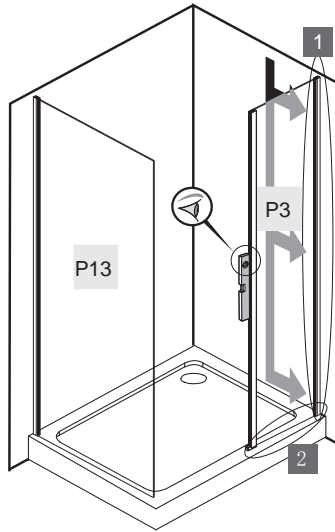
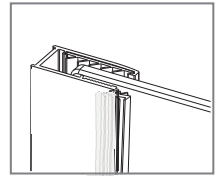
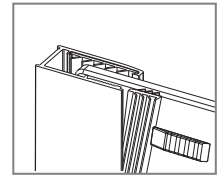
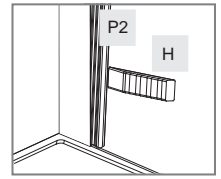
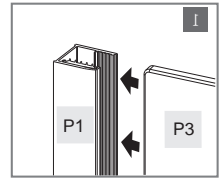
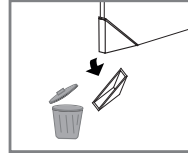
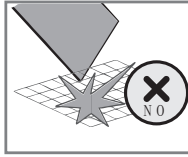
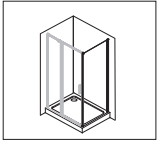

P2



x1

H



x1



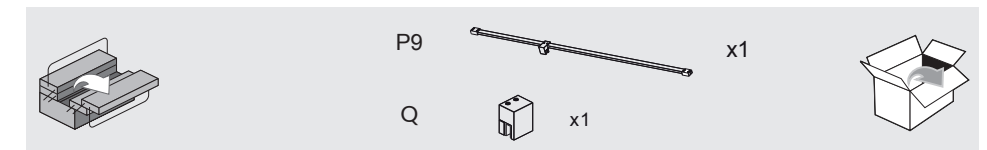
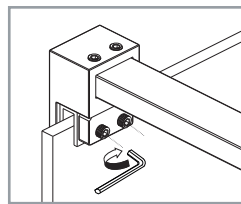
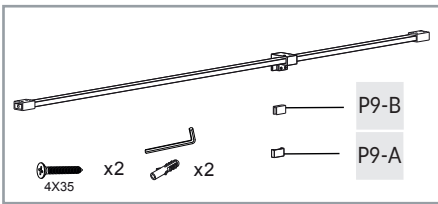
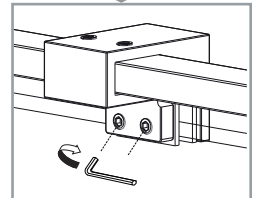
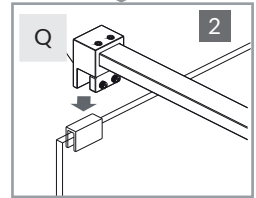
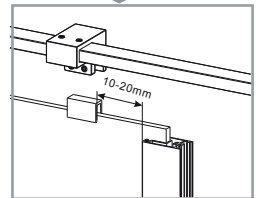
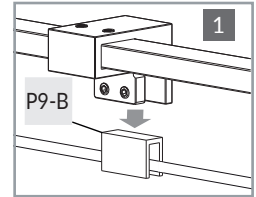
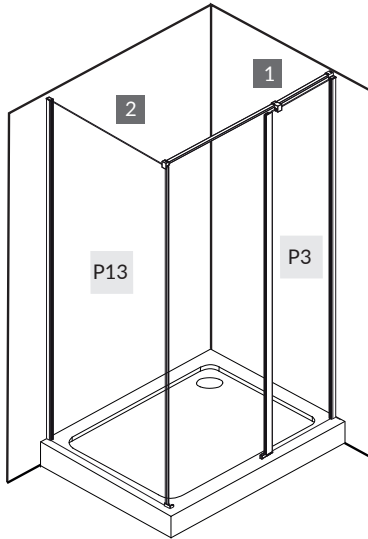
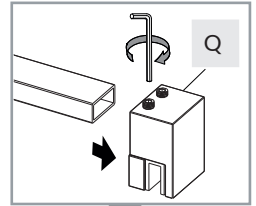
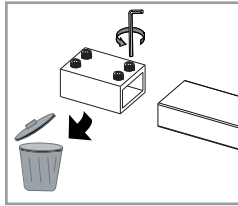
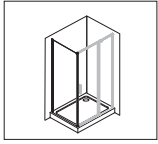

P9  x1

Q  x1



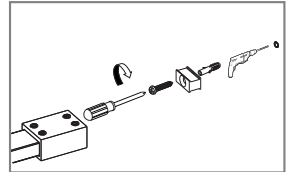
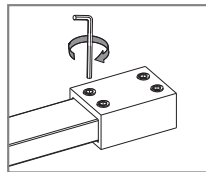
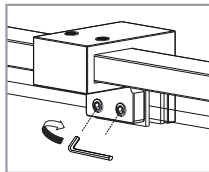
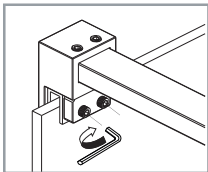
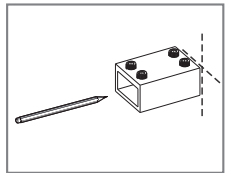
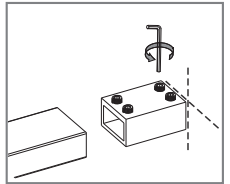
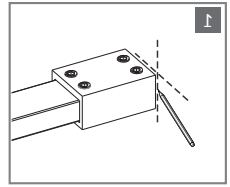
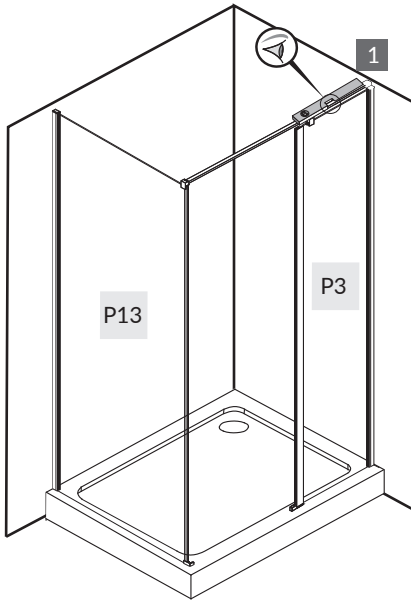
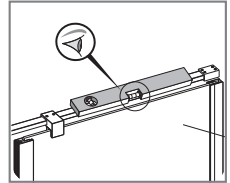
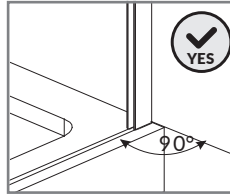
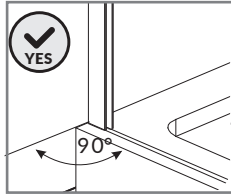
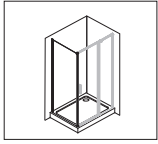

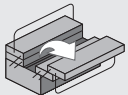
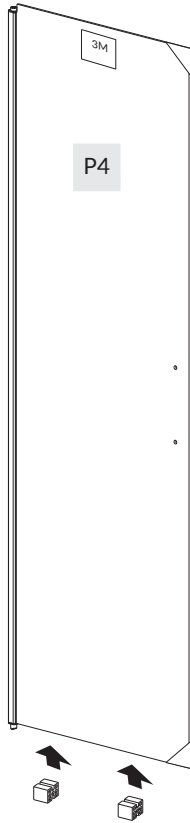
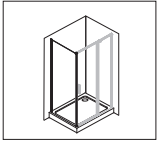

N2



x2



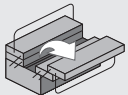
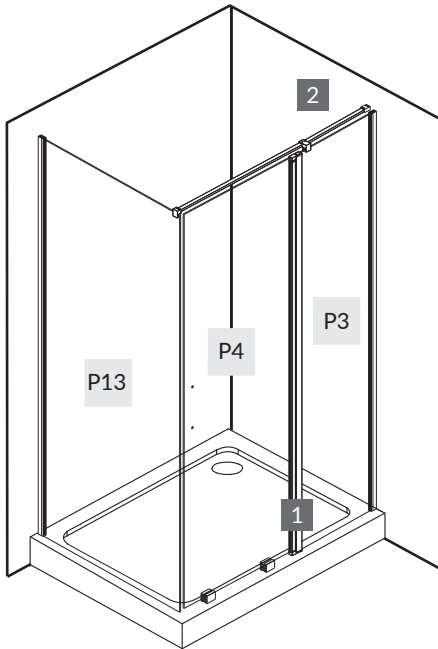
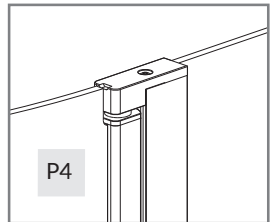
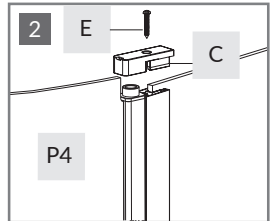
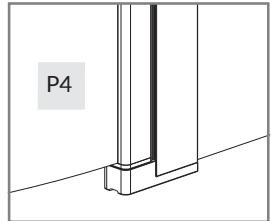
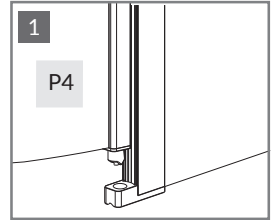
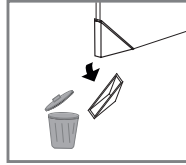
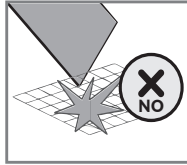
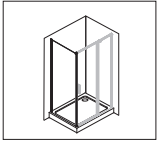

C

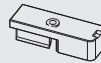

x1

E



x1



30.

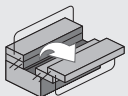
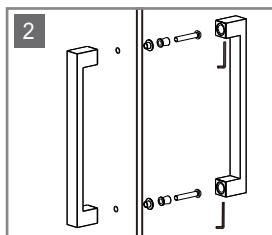
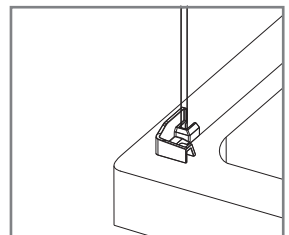
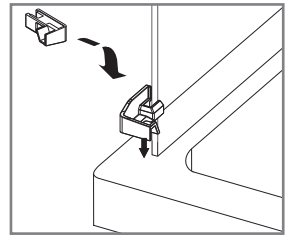
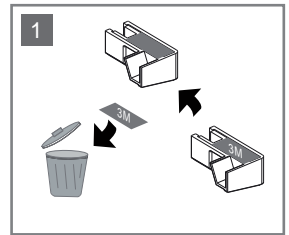
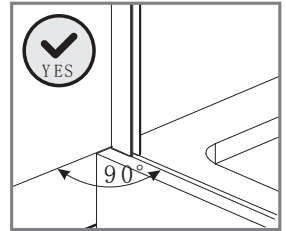
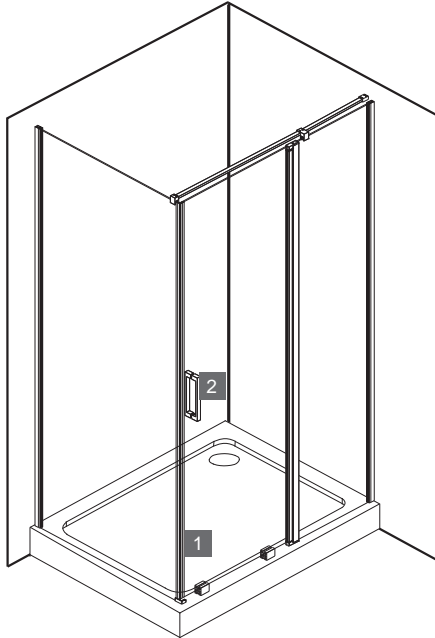
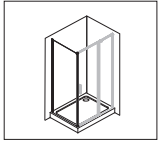

P5



x1



L2



x1



31.

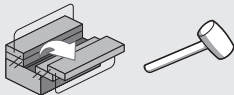
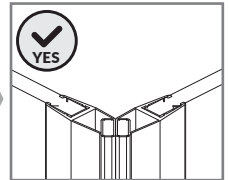
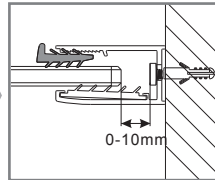
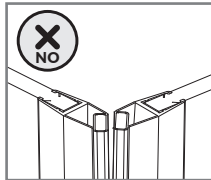
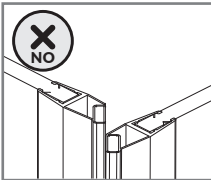
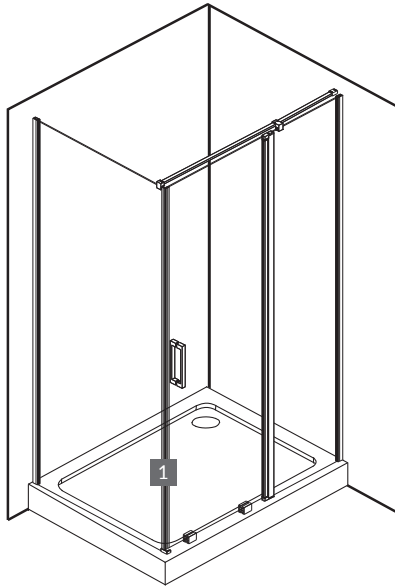
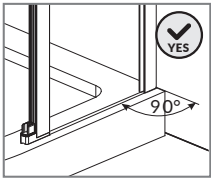
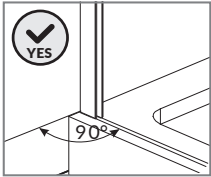
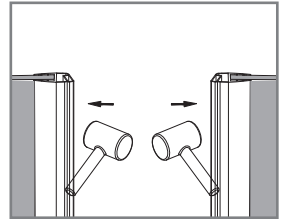
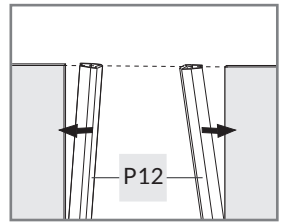
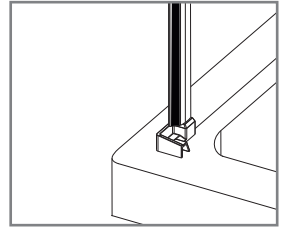
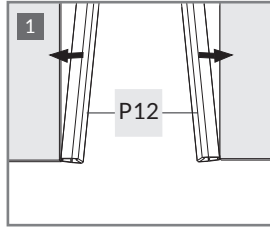
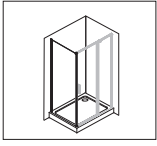

P12



x2



32.

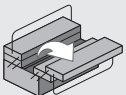
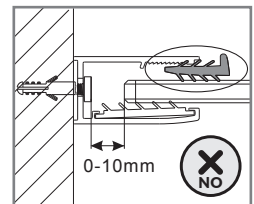
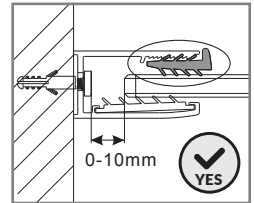
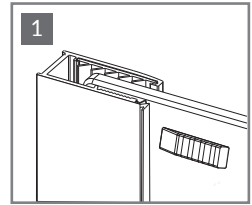
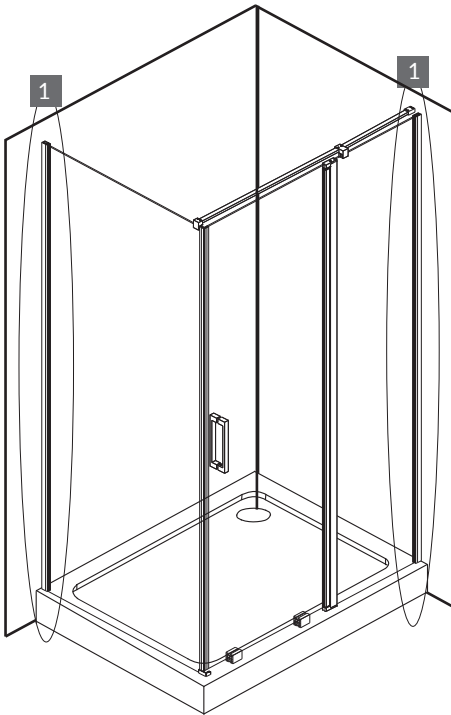
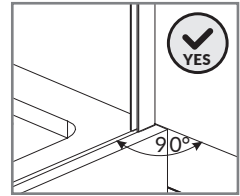
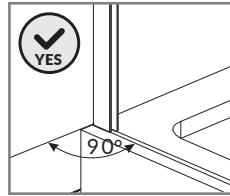
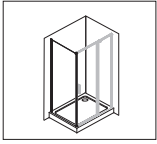

H



x1



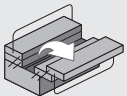
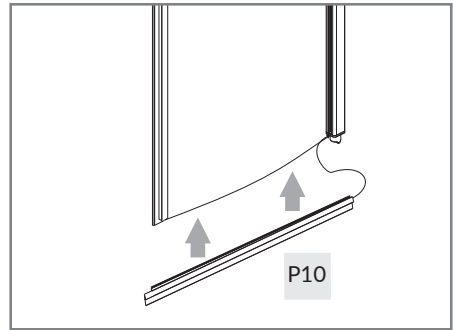
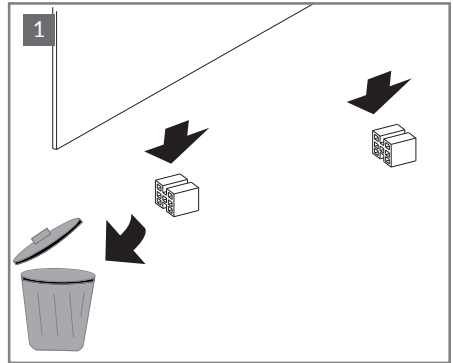
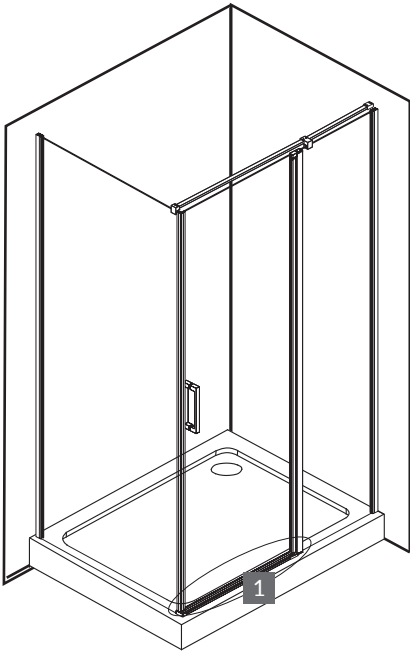
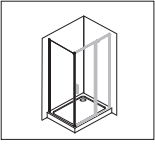

P10



x1



34.

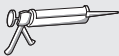
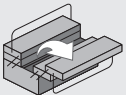
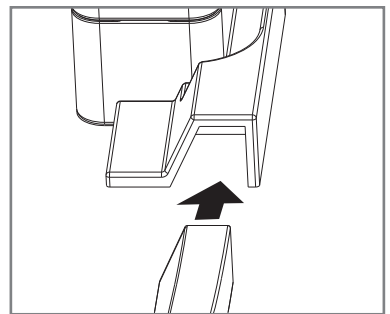
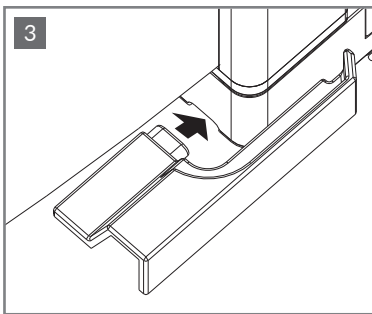
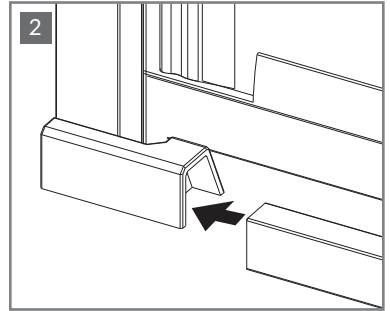
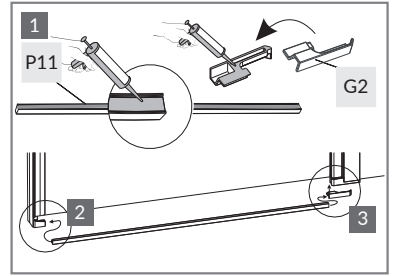
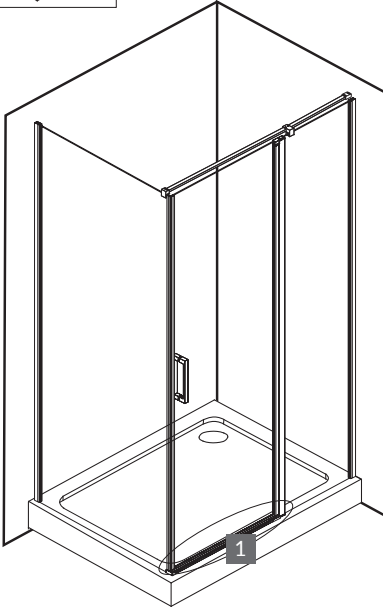
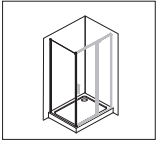

P11



x1

G2



x1



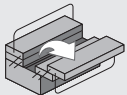
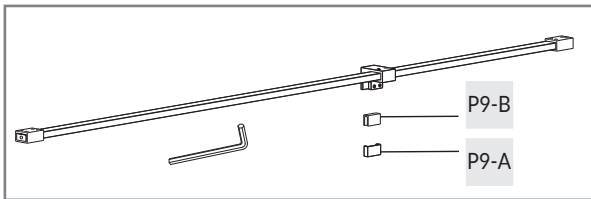
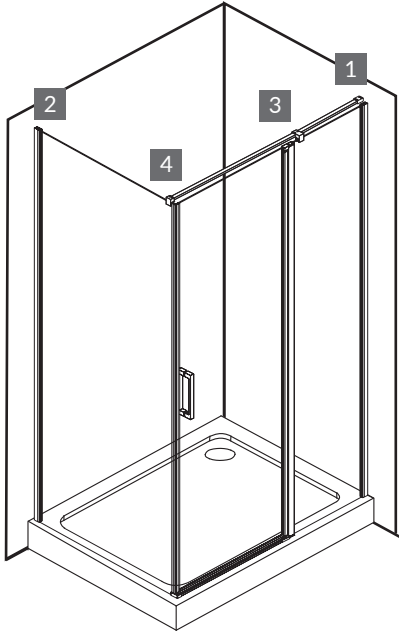
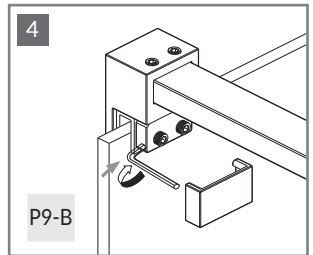
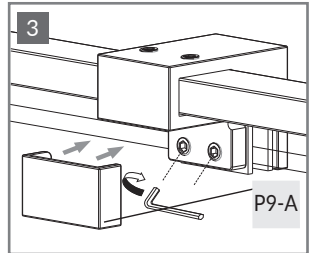
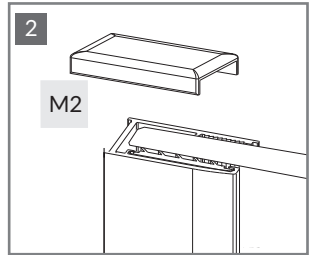
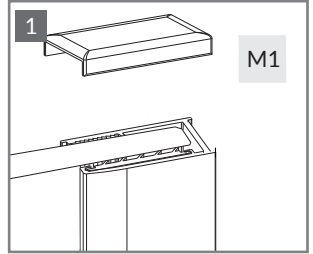
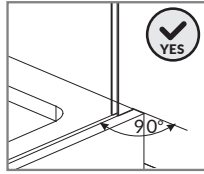
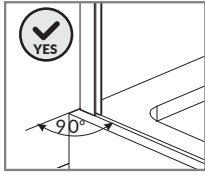
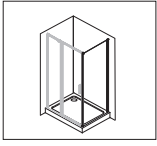

M2  x1

M1  x1



36.

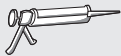
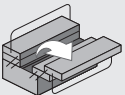
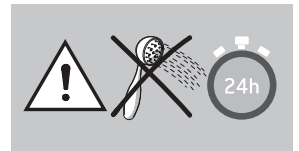
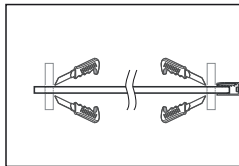
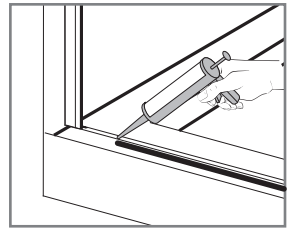
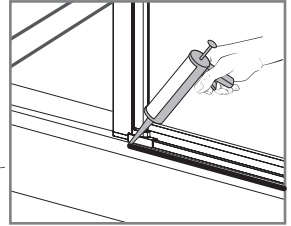
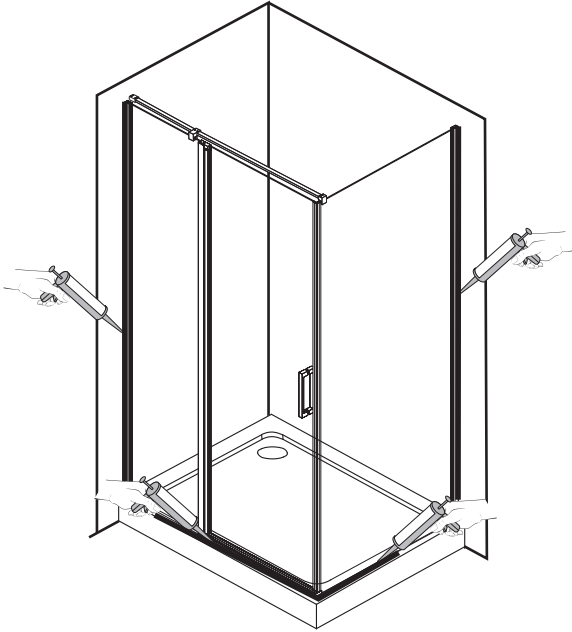
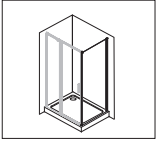



6.5<PH<7.5

